

Ensuring Power System Reliability through Service Specifications

PowerHour webinar series for consulting engineers

Experts you trust.
Excellence you count on.

Feb 24, 2022 1:00 Eastern / 10:00 Pacific
(1 PDH issued by Cummins Inc.)



**FOR
A WORLD
THAT'S
ALWAYS ON™**

Welcome!

Cummins PowerHour webinar series is designed to help our engineer partners to...

- Keep up to date on products, technology, and codes and standards development
- Interact with Cummins experts and gain access to ongoing technical support
- Participate at your convenience, live or on-demand
- Earn Professional Development Hours (PDH)

Technical tips:

- Audio is available through teleconference or Zoom application.
- Attendees are in "listen only" mode throughout the event.
- Use the Zoom Q&A Panel to submit questions, comments, and feedback throughout the event. Time is allotted at the end of the PowerHour to address Q&A.
- If the audio connection is lost, disconnected or experiences intermittent connectivity issues, please check your audio connection through the "Join Audio" or "Audio Connectivity" button at the bottom left of the Zoom application.
- Report technical issues using the Zoom Q&A Panel.



Asking a Question:

Q&A Button:

- For technical questions on today's topic
- Ask at anytime
- Not all questions may get answered but we'll do our best!



Chat Button:

- For general PowerHour or Zoom questions



Meet your panelists

Cummins instructors



Mark Taylor
Technical Marketing Advisor
Cummins Inc.



Brian Hargrave
Director of Power Generation
Field Service
Cummins Inc.

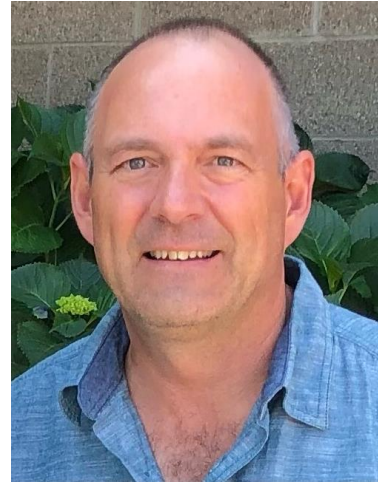

Jeff Mattivi
Special Projects Manager
Cummins Inc.

Cummins facilitator



Chad Hale
Technical Marketing
Advisor

Disclaimer

The views and opinions expressed in this course shall not be considered the official position of any regulatory organization and shall not be considered to be, nor be relied upon as, a Formal Interpretation.

Participants are encouraged to refer to the entire text of all referenced documents. In addition, when it doubt, reach out to the Authority Having Jurisdiction.



Course Objectives

Ensuring Power System Reliability through Service Specifications

Service and product maintenance are paramount to a reliable and NFPA 110-compliant power system. Few products are immune from time and neglect, and this is especially important for life-safety and critical backup power systems. Consultants and Specifying Engineers have early opportunities to ensure that the long-term care (and consequently, the reliability) of their designs is streamlined and easier for facility owners. This course seeks to help those in that position to “win the handoff” with key best practices.

After completing this course, participants will be able to:

- Describe why service is important for the reliability of a power system.
- Recognize what key components in a power system require routine maintenance.
- Identify how specifications can impact a consistent and reliable service regimen.



Why should a power system be maintained?

Code/Legal Compliance

Routine Maintenance and Operational Testing

8.1.1 The routine maintenance and operational testing program shall be based on all of the following:

- (1) Manufacturer's recommendations
- (2) Instruction manuals
- (3) Minimum requirements of this chapter
- (4) The authority having jurisdiction

Related Content

NFPA 110 Time-to-Readiness Overview
[White Paper](#)
[PowerHour](#)

Code/Legal Compliance

Routine Maintenance and Operational Testing

8.1.1 The routine maintenance and operational testing program shall be based on all of the following:

- (1) Manufacturer's recommendations
- (2) Instruction manuals
- (3) Minimum requirements of this chapter
- (4) The authority having jurisdiction

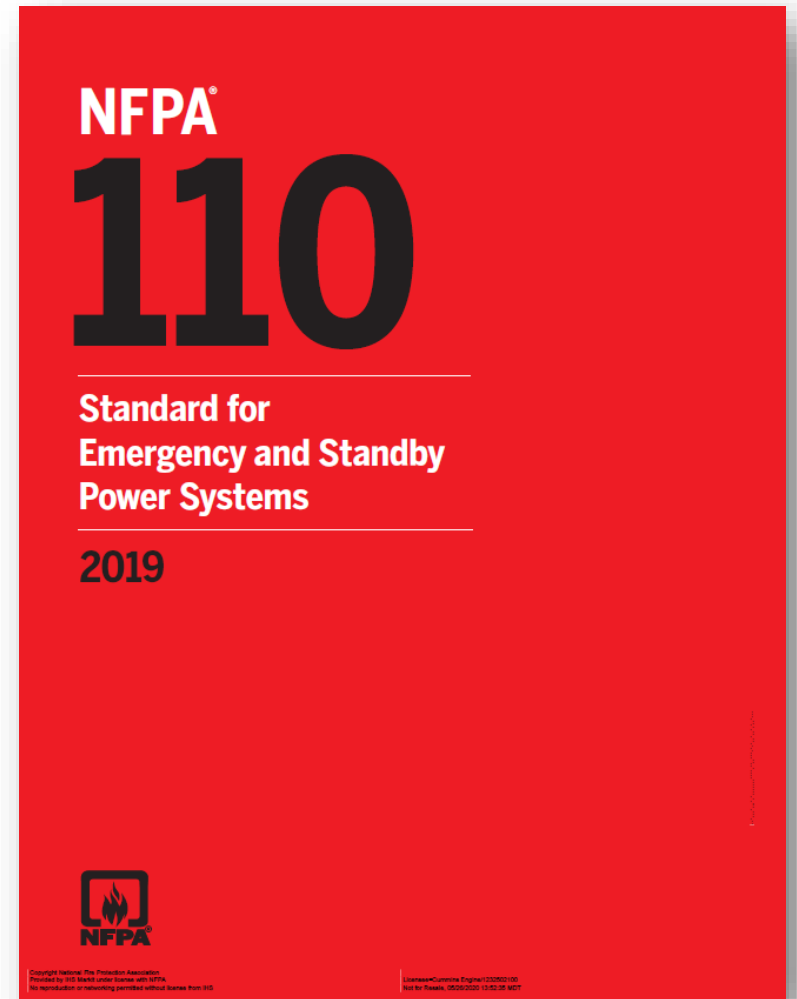

AHJ Requirements

Routine Maintenance and Operational Testing

8.1.1 The routine maintenance and operational testing program shall be based on all of the following:

- (1) Manufacturer's recommendations
- (2) Instruction manuals
- (3) Minimum requirements of this chapter
- (4) The authority having jurisdiction

Related Content

EPA Emissions Regulations

[PowerHour White Paper](#)

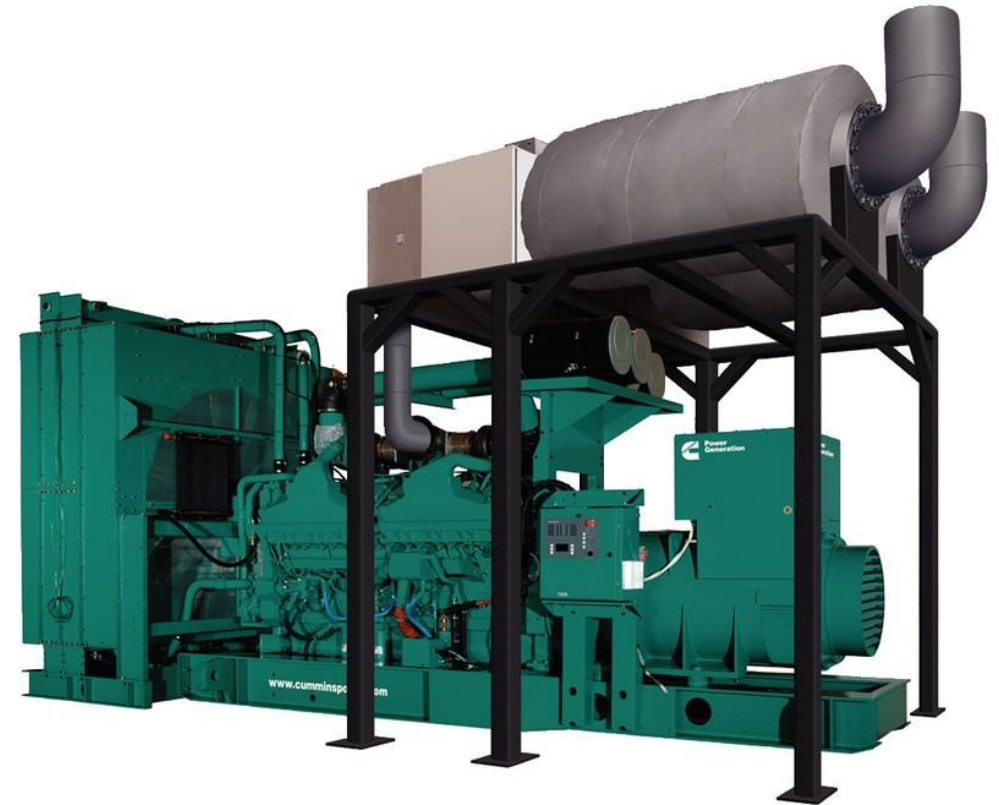

Manufacturer Requirements

Routine Maintenance and Operational Testing

8.1.1 The routine maintenance and operational testing program shall be based on all of the following:

- (1) Manufacturer's recommendations
- (2) Instruction manuals
- (3) Minimum requirements of this chapter
- (4) The authority having jurisdiction

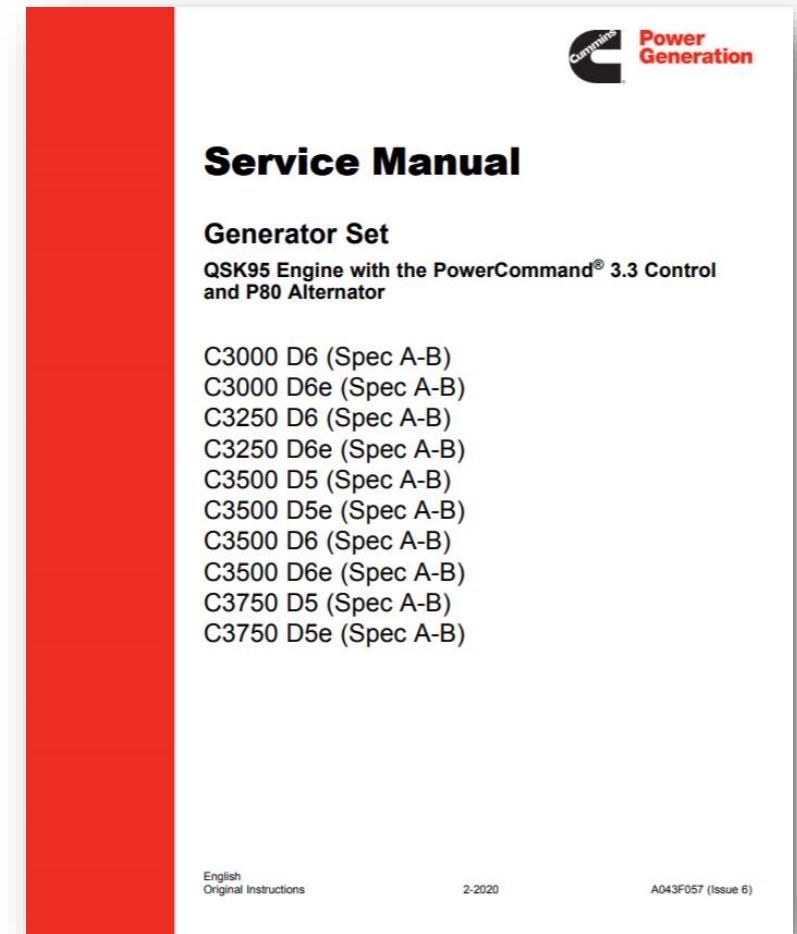

Electrical Power Security

- An outage is not the time to learn your backup power system is not running optimally
- “Ounce of prevention is worth a pound of cure”
 - Improved power system uptime
 - Increased power system lifespan
 - Reduced operating costs





What parts/components of a power system should be maintained?

Starting Battery Maintenance

8.3.6.1 Maintenance of lead-acid batteries shall include the monthly testing and recording of electrolyte specific gravity. Battery conductance testing shall be permitted in lieu of the testing of specific gravity when applicable or warranted.

8.3.6.2 Defective batteries shall be replaced immediately upon discovery of defects.



Fuel Quality Testing

8.3.7 A fuel quality test shall be performed at least annually using appropriate ASTM standards or the manufacturer's recommendations.

Related Content

Specifying Fuel Sources

[Application Guidelines T-030](#)

[PowerHour](#)



Testing with Load

8.4.2 Diesel generator sets in service shall be exercised at least once monthly, for a minimum of 30 minutes, using one of the following methods:

- (1) Loading that maintains the minimum exhaust gas temperatures as recommended by the manufacturer
- (2) Under operating temperature conditions and at not less than 30 percent of the EPS standby nameplate kW rating

8.4.2.3 Diesel-powered EPS installations that do not meet the requirements of 8.4.2 shall be exercised monthly with the available EPSS load and shall be exercised annually with supplemental loads at not less than 50 percent of the EPS nameplate kW rating for 30 continuous minutes and at not less than 75 percent of the EPS nameplate kW rating for 1 continuous hour for a total test duration of not less than 1.5 continuous hours.



Transfer Switch Maintenance

8.3.4* Transfer switches shall be subjected to a maintenance and testing program that includes all of the following operations:

- (1) Checking of connections
- (2) Inspection or testing for evidence of overheating and excessive contact erosion
- (3) Removal of dust and dirt
- (4) Replacement of contacts when required

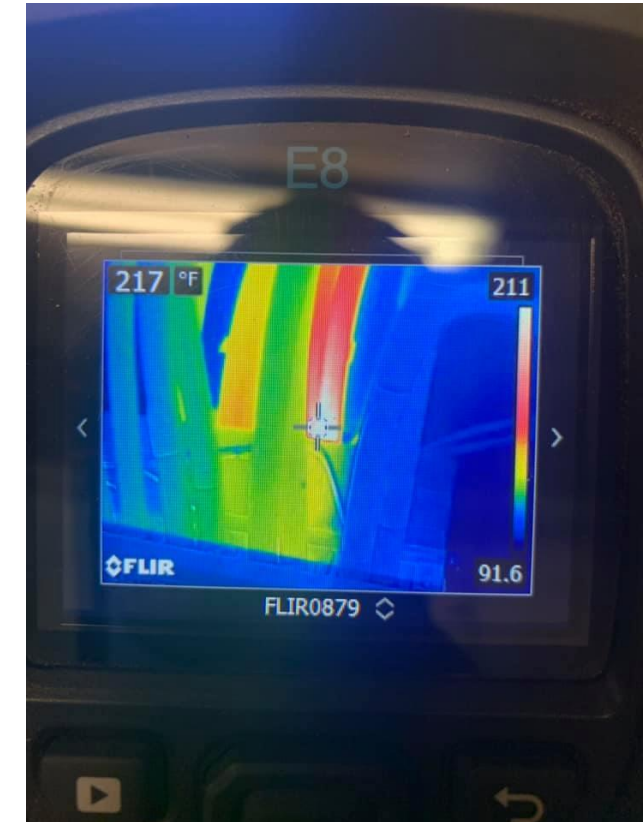
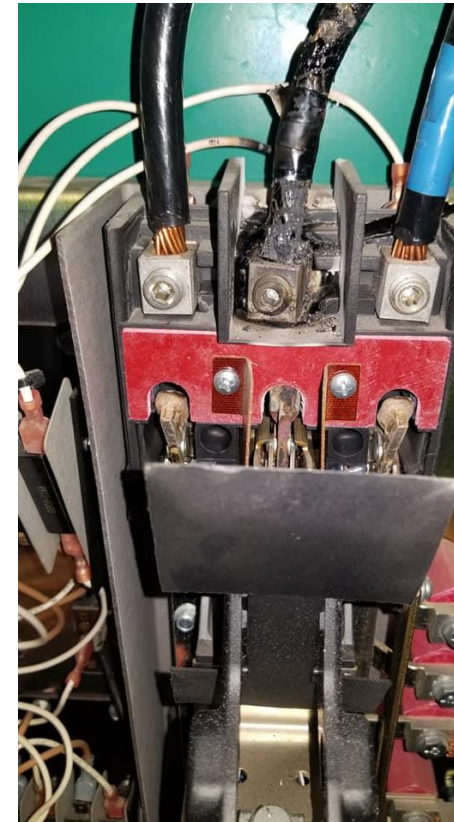

Paralleling Gear

8.3.5* Paralleling gear shall be subject to an inspection, testing, and maintenance program that includes all of the following operations:

- (1) Checking connections
- (2) Inspecting or testing for evidence of overheating and excessive contact erosion
- (3) Removing dust and dirt
- (4) Replacing contacts when required
- (5) Verifying that the system controls will operate as intended

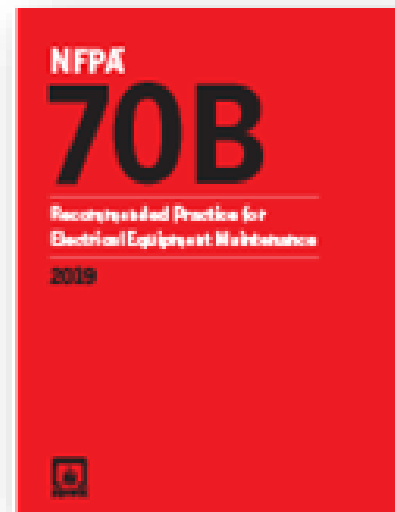

Maintenance Record Requirements

8.3.3 A written schedule for routine maintenance and operational testing of the EPSS shall be established.

8.5.1 Records shall be created and maintained for all EPSS inspections, operational tests, exercising, repairs and modifications.

8.5.2 Records required in 8.5.1 shall be made available to the authority having jurisdiction on request.

8.5.3 The permanent record shall include the following:

- (1) The date of the maintenance report
- (2) Identification of the servicing personnel
- (3) Notation of any unsatisfactory condition and the corrective action taken, including parts replaced
- (4) Testing of any repair for the time as recommended by the manufacturer

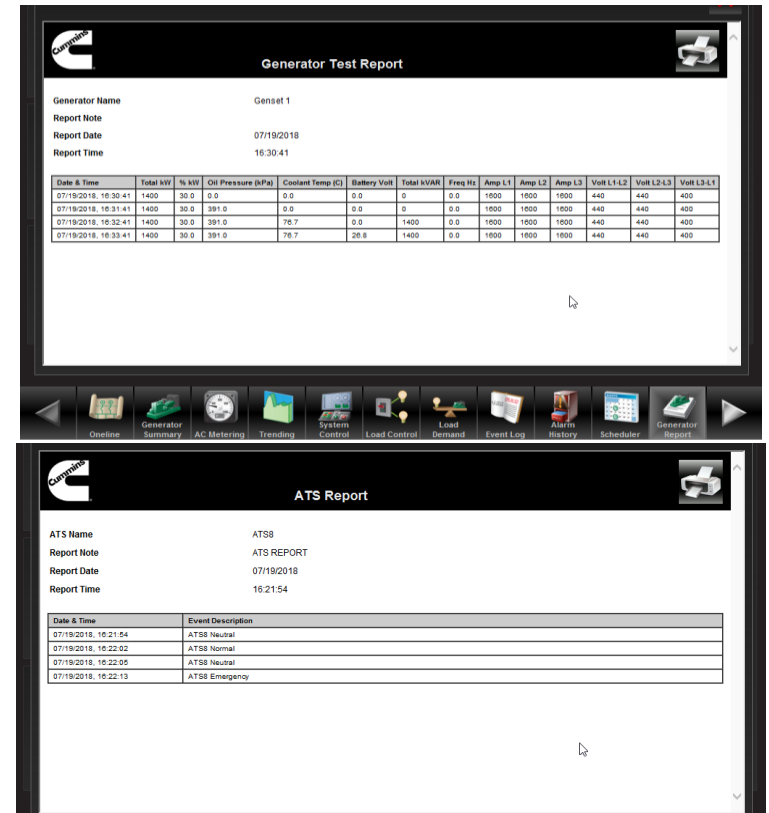

Related Content

System Level Control
[PowerHour](#)

If Nothing Else, Remember:

- Fluids do not have infinite life
- Electrical components can have mechanical failures
- Rubber and filter components age and degrade
- Dust and pests will find a way to intrude

**Related
Content**

Generator Set Maintenance
[White Paper](#)





How can one set up their power system specifications or design for optimal reliability?

Start with a Good Baseline

Prototype Testing



... validates design

Factory Testing



... validates assembly

Site Testing



... validates installation

Maintenance Testing



... relies on a foundation of all the testing that preceded it

Related
Content

**Specifying Testing for
Reliable Power Systems**
[PowerHour](#)

Spec Note

- Manufacturer to provide records of prototype testing.
- Manufacturer to include factory test report with completed product.
- Engage a factory-authorized service representative to test and inspect components, assemblies, and equipment installations, including connections. Report and record results of tests and inspections in writing.

Consumables

Batteries: Shall be well maintained

Spec Note Require vendors to provide starting batteries and battery chargers sized appropriately for use with the generator set configuration.

Fuel: Diesel requires inspection and polishing

Spec Note Fuel-Tank Capacity: Minimum 133 percent of total fuel required for planned operation plus fuel for periodic maintenance operations between fuel refills.

Set-mounted cooling systems: are simpler & need less coolant

Spec Note Integral Cooling System: Closed loop, liquid cooled, with radiator factory mounted on engine generator set mounting frame and integral engine-driven coolant pump.

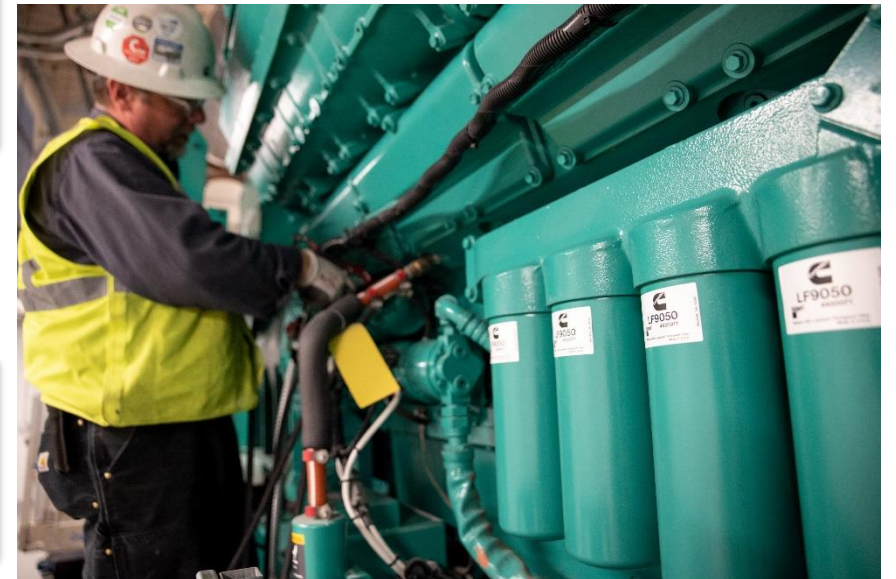

Help Make it Easy to Exercise

Monthly exercise with load is crucial

- Where will the load bank be placed?
- How will the cables be routed?

Consider providing means to couple external load banks alongside temporary power source connections

- Driven by 2017 revision of NEC (NFPA 70)

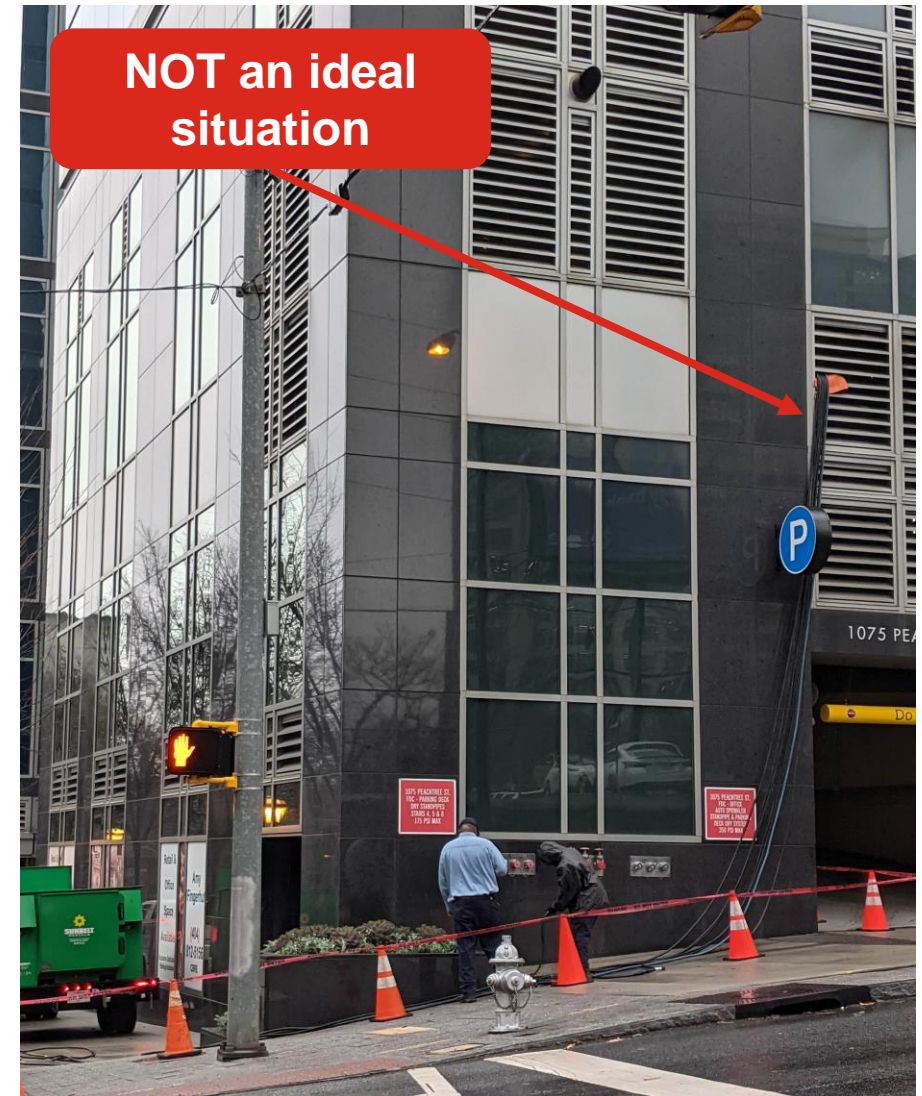

Help Make it Easy to Exercise

Monthly exercise with load is crucial

- Where will the load bank be placed?
- How will the cables be routed?

Consider providing means to couple external load banks alongside temporary power source connections

- Driven by 2017 revision of NEC (NFPA 70)

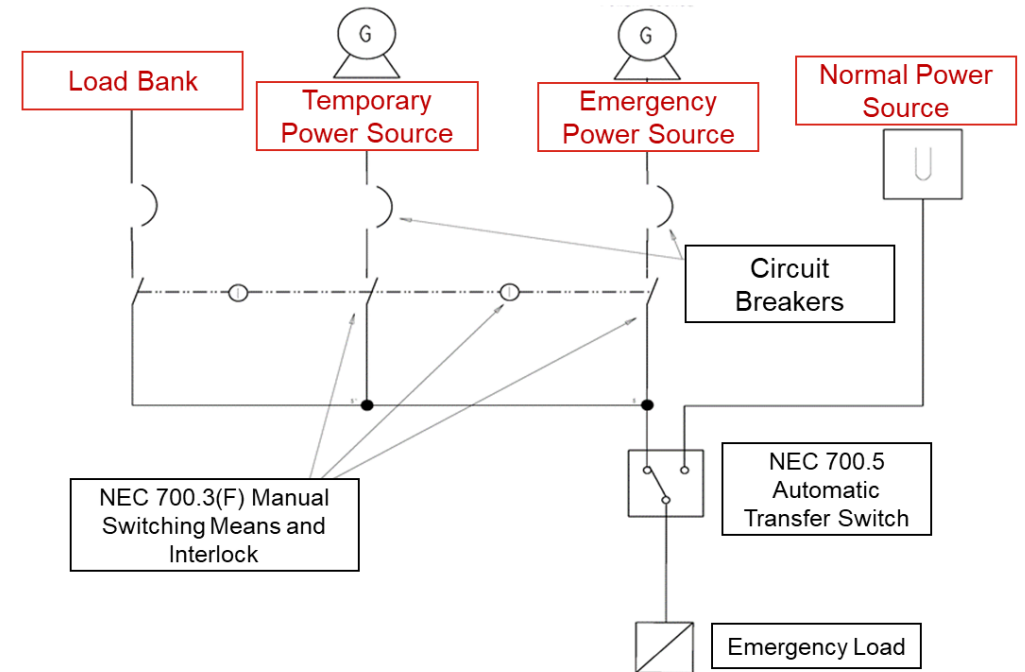

Spec Note

- Specify a right-sized permanently installed load bank to allow for proper loading during regular testing.
- If temporary power source connections are being permanently installed, add permanent load back connections.

Minimizing Downtime with Confidence

- Travel times for technicians and lead times for parts can add up for facility owners.
- Work with the manufacture of the equipment or a firm that stocks parts for your equipment locally or as a minimum regionally.
- For facility owners: seek to work with the same qualified firm year after year to drive consistent support

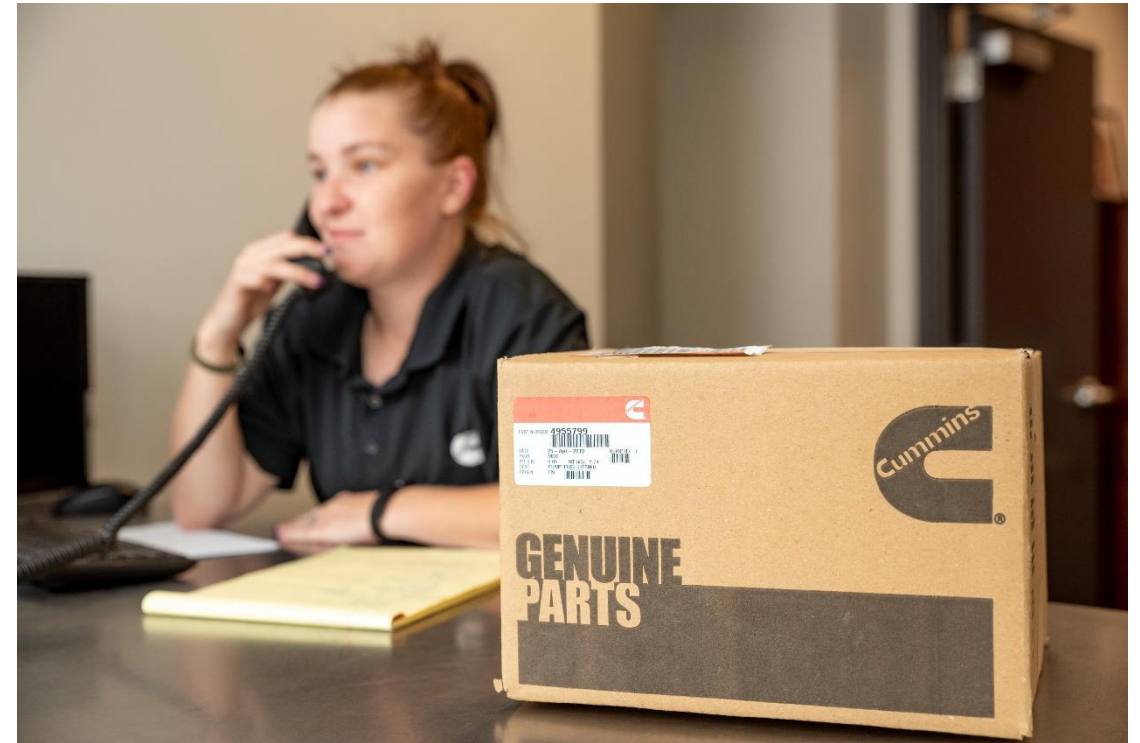

Spec Note Manufacturer shall have a local branch with common spare parts and factory-trained technicians within a certain proximity of site.

Remote Monitoring Technologies

- Facility owners aren't always immediately close to their power system.
 - Monitoring via an app offers flexibility
- The initial trip to a site to diagnose the problem can add downtime.
 - Remote monitoring solutions allow the service provider to get an advanced first look.
 - Planned maintenance can be optimized based on this data.



Spec Note Provide a digital cloud/remote monitoring solution for observing power system status and statistics.

Keeping Things Simple

- A project built with a disparate mix of lowest-bid suppliers may pose a higher risk of integration challenges.
- Consider manufacturers that serve and supply the entire power system.
- If it's easy to commission, it should be easy to maintain.
- Be known for winning the hand off with facility owners!



Spec Note Source Limitations: Obtain packaged engine generators and auxiliary components from single source from single manufacturer.

Design for Service

- Poor access can result in painful service experiences down the road.
 - Fluids and consumable items
 - Replacement Parts
- Consider allowing space for potential upgrades and expansions.

Spec Note

- Indicate access requirements affected by height of subbase fuel tank.
- Include details of equipment assemblies. Indicate dimensions, weights, loads, required clearances, method of field assembly, components, and location and size of each field connection.
- Identify fluid drain ports and clearance requirements for proper fluid drain.

Related Content

Generator Set Installation
[Application Guidelines T-030](#)

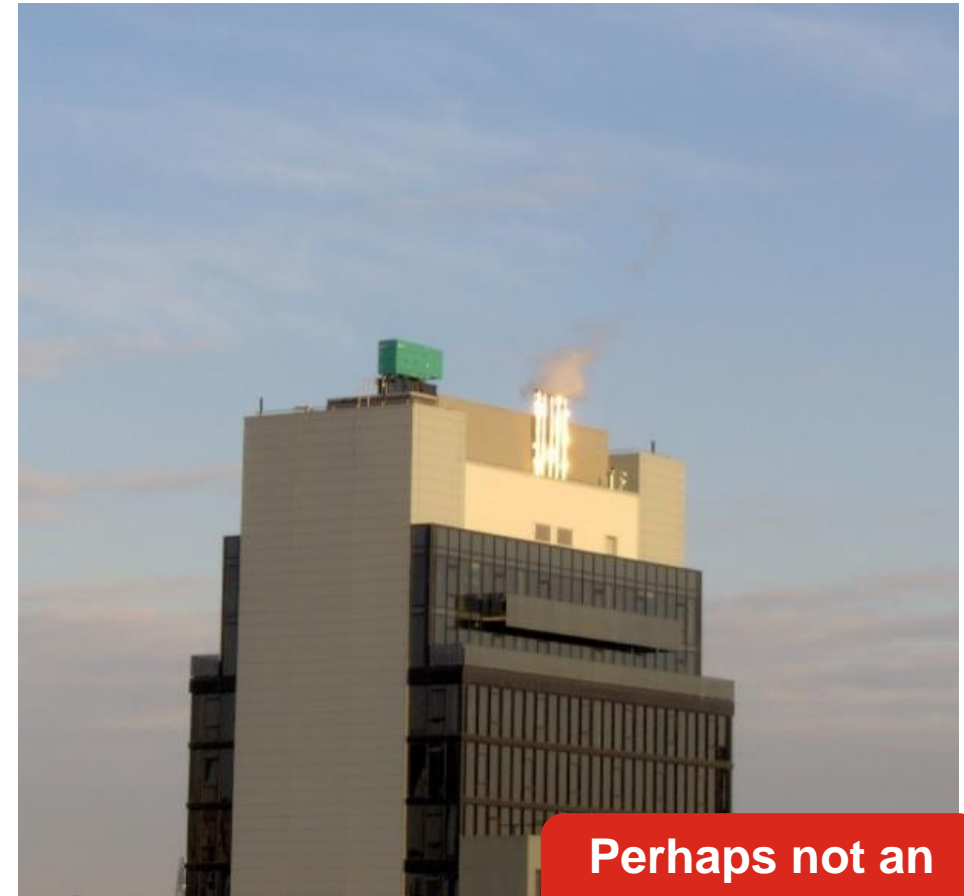

Perhaps not an ideal situation

Course Summary

Ensuring Power System Reliability through Service Specifications

- Describe why service is important for the reliability of a power system.
- Recognize what key components in a power system require routine maintenance.
- Identify how specifications can impact a consistent and reliable service regimen.

Specify:

- Manufacturers who have a local presence to the site.
- Manufacturers with trained technicians capable of servicing the entire power system.

Avoid specifying:

- A narrow range of different preferred suppliers for each component, driving potential complexity.

Additional Resources

Cummins White Papers

- [10-Second Time to Readiness](#)
- [EPA Emission Regulations: What They Mean for Diesel Powered Generator Systems](#)
- [Maintenance is One Key to Diesel Generator Set Reliability](#)

Cummins PowerHour On-Demand Webinars

- [NFPA 110 Type 10 Requirements for Emergency Power Systems](#)
- [Emissions and Air Permitting Requirements for Standby Generator Sets](#)
- [Considerations for Specifying Generator Set Fuel Sources](#)
- [The Role of a System Level Control in a Power System](#)
- [Specifying Generator Set Testing for Reliable Power Systems](#)

Application Manuals

- [T-030 – Liquid Cooled Generator Sets](#)

Power topic #7004 | Technical information from Cummins Power Generation

Maintenance is one key to diesel generator set reliability

> White paper
By Timothy A. Loehlein, Project Manager



Our energy working for you.™

Diesel engines comprise the vast majority of prime movers for standby power generators because of their reliability, durability and performance under load. Diesel powered generators are depended on for back-up power systems in the most critical locations: hospitals, airports, government buildings, telecommunications facilities, and even nuclear power plants. In standby power applications, diesel generators can start and assume full-rated load in less than 10 seconds, and they typically can go 30,000 hours or more between major overhauls.

This remarkable set of credentials is unique to diesel engines, but like any mechanical device, maintenance is critical for ensuring that a diesel powered standby generator will start and run when needed. Facilities with qualified in-house technical personnel can often perform required preventive maintenance on diesel generators. Other facility managers prefer to contract with a local service provider or power system distributor for regular maintenance service—especially if they have generators in multiple locations. (For unplanned maintenance, engine repairs or overhauls, it is always best to use qualified diesel service technicians.)

Preventive maintenance

Because of the durability of diesel engines, most maintenance is preventive in nature. Preventive diesel engine maintenance consists of the following operations:

- General inspection
- Lubrication service
- Cooling system service
- Fuel system service
- Servicing and testing starting batteries
- Regular engine exercise

It is generally a good idea to establish and adhere to a schedule of maintenance and service based on the specific power application and the severity of the environment. For example, if the generator set will be used frequently or subjected to extreme operating conditions, the recommended service intervals should be reduced accordingly. Some of the factors that can affect the maintenance schedule include:

- Using the diesel generator set for continuous duty (prime power)
- Extreme ambient temperatures



A well-planned maintenance program is essential to the operation of any power generation system.

Q&A



Please type your questions, comments and feedback in the **Zoom Q&A** window.

Copy of the presentation, and link to the recording will be provided in a follow up email within a 1-2 business days.

Please complete the brief survey upon exiting the webinar!



Mark Taylor

Technical Marketing Advisor
Cummins Inc.



Brian Hargrave

Director of Power
Generation Field Service
Cummins Inc.

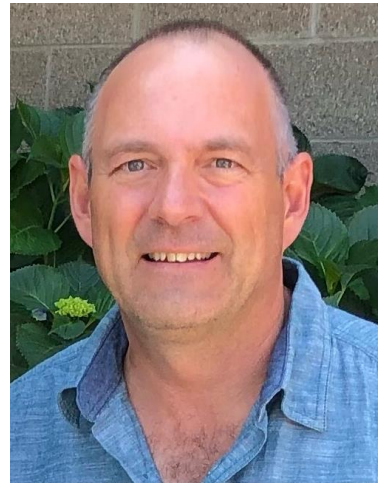

Jeff Mattivi

Special Projects Manager
Cummins Inc.



Chad Hale

Technical Marketing
Advisor

Following This Event...



First Email (ASAP)

1 Professional Development Hour (PDH) Certificate



Second Email (3-5 Business Days)

Video Recording
Copy of slide deck



Please engage with our exit survey!



Power Suite

[Power Suite](#) is where to find past PowerHours, Application Manuals, Sizing Tools, Data Sheets, and more!

Please contact us if you have any questions related to the PowerHour webinar (PowerGenChannel@cummins.com)

More From Cummins!



Cummins White Papers

[Click here](#) to subscribe!



Brightest Bulbs Podcast

[Click here](#) to hear about the latest innovations in energy and power!



Cummins On-Demand Webinars

[Click here](#) for our full webinar library!

[Click here](#) to subscribe!



New Transfer Switch Product

Your Strongest Link to Reliable Power is Now Here! Learn more about the PowerCommand® X-Series Transfer Switch [here!](#)



Upcoming Live PowerHour:

04/28/2022 – Transfer Switches Features and Functions

LOCAL CUMMINS

Sales Application Engineers

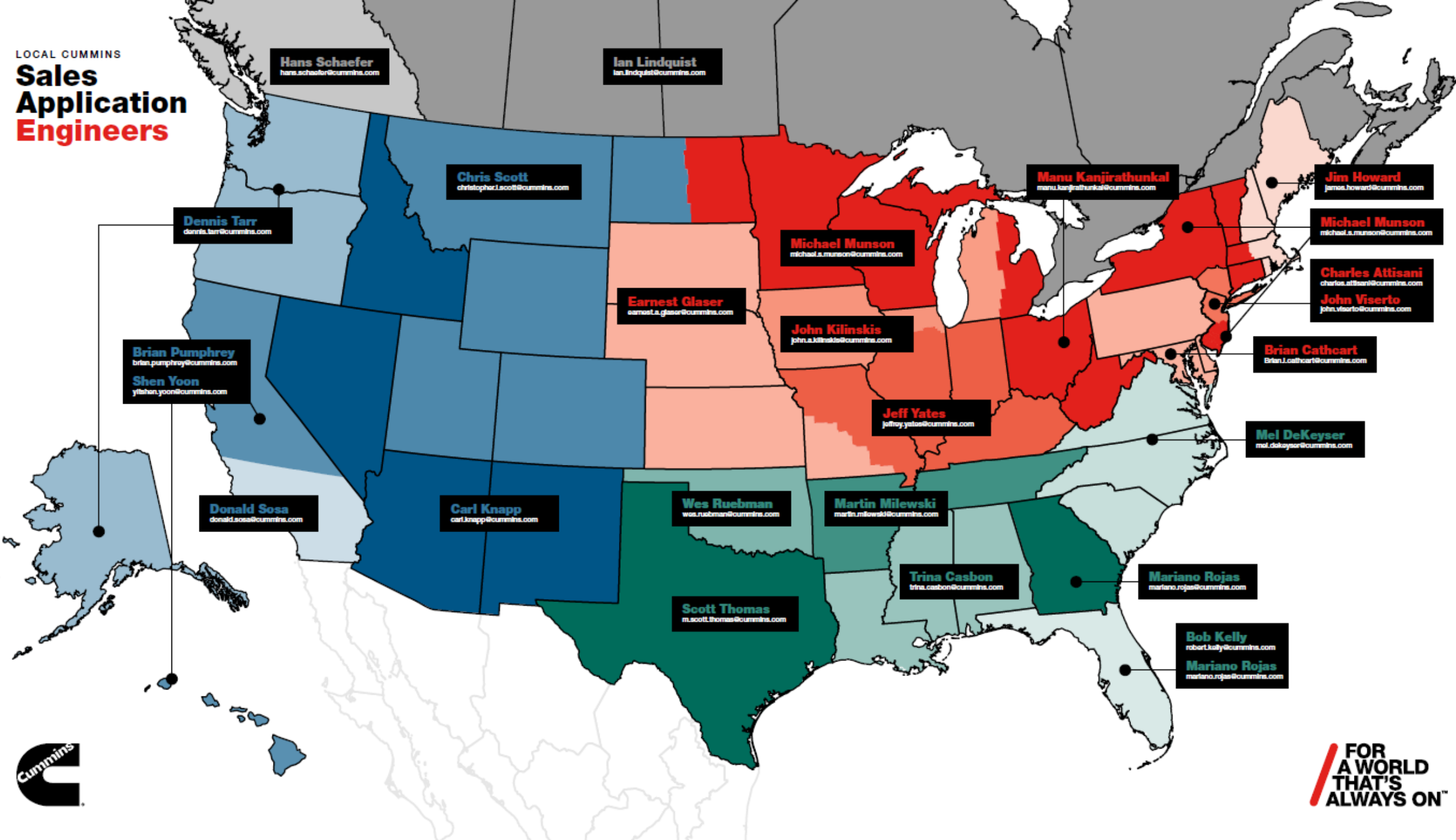

FOR A WORLD THAT'S ALWAYS ON™

