



# Operator Manual

Cummins **Onan**

Performance you rely on.™



## Hybrid Quiet Diesel Power System HQDSB

HQDSB (Spec A–B)  
Power Unit HQDPB (Spec A–B)  
Primary Inverter Charger HQDVA (Spec A–C)  
Secondary Inverter Charger HQDVB (Spec A–B)  
Transfer Switch HQDTA (Spec A–C)

**California**

**Proposition 65 Warning**

**Diesel engine exhaust and some of its constituents are known to the State of California to cause cancer, birth defects, and other reproductive harm.**



**WARNING**



**Do not use this genset on a boat  
Such use may violate U. S. Coast Guard  
regulations and can result in  
severe personal injury or death from  
fire, electrocution, or  
carbon monoxide poisoning**

# Table of Contents

---

| SECTION  | PAGE |
|--|------|
| SAFETY PRECAUTIONS .....                       | iv   |
| 1. INTRODUCTION .....                          | 1-1  |
| About this Manual .....                        | 1-1  |
| Hybrid Power System Component Nameplates ..... | 1-1  |
| How to Obtain Service .....                    | 1-3  |
| Engine Emissions Compliance .....              | 1-3  |
| Features .....                                 | 1-4  |
| Modes of Operation .....                       | 1-5  |
| 2. OPERATING THE HYBRID POWER SYSTEM .....     | 2-1  |
| Pre-Start Checks .....                         | 2-1  |
| EveryDay Operation .....                       | 2-1  |
| Enabling AUTO .....                            | 2-2  |
| Inverter Mode—Manual Control .....             | 2-4  |
| Generator Mode—Manual Control .....            | 2-5  |
| Shore Power Mode .....                         | 2-6  |
| 3. POWER UNIT OPERATION AND MAINTENANCE .....  | 3-1  |
| General .....                                  | 3-1  |
| Power Unit Control Panel .....                 | 3-2  |
| Remote Control Switch .....                    | 3-2  |
| Recommended Fuel .....                         | 3-4  |
| Recommended Coolant .....                      | 3-4  |
| Recommended Engine Oil .....                   | 3-5  |
| Operating at High Altitude .....               | 3-5  |
| Operating in Cold Weather .....                | 3-5  |
| Operating in Hot Weather .....                 | 3-5  |
| Operating in Dusty Environments .....          | 3-5  |
| New engine Break-In .....                      | 3-6  |
| Exercising the Hybrid Power System .....       | 3-6  |
| Storage .....                                  | 3-6  |
| Periodic Maintenance Schedule .....            | 3-7  |

| <b>SECTION</b>  | <b>PAGE</b> |
|---|-------------|
| General InspectionS .....                                     | 3-8         |
| Checking Engine Oil Level .....                               | 3-9         |
| Changing Engine Oil and Oil Filter .....                      | 3-10        |
| Replacing the Air Filter Element .....                        | 3-11        |
| Cleaning the Spark Arrestor .....                             | 3-12        |
| Replacing the Fuel Filter .....                               | 3-13        |
| Maintaining Engine and Inverter/Charger Cooling SystemS ..... | 3-14        |
| <b>4. INVERTER/CHARGER .....</b>                              | <b>4-1</b>  |
| General .....   | 4-1         |
| Maintenance .....   | 4-1         |
| <b>5. TRANSFER SWITCH .....</b>                               | <b>5-1</b>  |
| General .....   | 5-1         |
| Maintenance .....   | 5-1         |
| <b>6. COACH BATTERIES .....</b>                               | <b>6-1</b>  |
| Charging the Coach Batteries .....                            | 6-1         |
| Maintaining the Coach Batteries .....                         | 6-1         |
| Equalizing the Coach Batteries .....                          | 6-2         |
| Storing the Coach Batteries .....                             | 6-2         |
| Replacing the Coach Batteries .....                           | 6-3         |
| Connecting the Coach Battery Cables .....                     | 6-4         |
| Replacing a Coach Battery Fuse .....                          | 6-6         |
| <b>APPENDIX A. OPERATOR PANEL .....</b>                       | <b>A-1</b>  |
| About the Operator Panel .....                                | A-1         |
| Home Screen .....   | A-2         |
| AUTO Button .....   | A-3         |
| Clock Button .....  | A-6         |
| Manual Button .....   | A-7         |
| Status Menu .....   | A-8         |
| Batt Status .....   | A-9         |
| Auto Status .....   | A-10        |
| Gen Status .....  | A-11        |
| Inv Status .....  | A-12        |
| Shore Status .....  | A-13        |
| Fault Information .....                                       | A-14        |

| <b>SECTION</b>                                | <b>PAGE</b> |
|---|-------------|
| Setup Menu .....                              | A-15        |
| Auto Setup .....                              | A-16        |
| Shore Breaker .....                           | A-17        |
| Screen Setup .....                            | A-18        |
| Service Menu .....                            | A-19        |
| Input Setup .....                             | A-20        |
| Battery Setup .....                           | A-21        |
| Equalize .....                                | A-22        |
| About .....                                   | A-24        |
| Warning and Prompt Screens .....              | A-25        |
| APPENDIX B. TROUBLESHOOTING SYMPTOMS .....    | B-1         |
| Fault Code Blinking .....                     | B-1         |
| Restoring Fault Code Blinking .....           | B-1         |
| APPENDIX C. TROUBLESHOOTING FAULT CODES ..... | C-1         |
| APPENDIX D. BATTERY INTERCONNECTIONS .....    | D-1         |
| APPENDIX E. SPECIFICATIONS .....              | E-1         |



# SAFETY PRECAUTIONS

---

Thoroughly read the **OPERATOR'S MANUAL** before operating the Hybrid Quiet Diesel Power System (Hybrid Power System). Safe operation and top performance can only be obtained when equipment is properly operated and maintained.

The following symbols in this manual alert you to potential hazards to the operator, service person and equipment.

**⚠ DANGER** alerts you to an immediate hazard that will result in severe personal injury or death.

**⚠ WARNING** alerts you to a hazard or unsafe practice that can result in severe personal injury or death.

**⚠ CAUTION** alerts you to a hazard or unsafe practice that can result in personal injury or equipment damage.

When equipped with an integral or add-on Automatic Generator Starting System (AGS) control, exhaust carbon monoxide (CO), electric shock, and moving parts hazards are possible due to unexpected starting. Turn off AGS whenever performing maintenance or service, when the vehicle is stored between uses, is awaiting service, or is parked in a garage or other confined area

## ENGINE EXHAUST IS DEADLY

- Inspect for exhaust leaks at every startup and after every eight hours of running.
- Learn the symptoms of carbon monoxide poisoning in the genset Operator's Manual.
- Never sleep in the vehicle while the genset is running unless the vehicle is equipped with a working carbon monoxide detector.
- Do not operate the genset when the vehicle is parked in a confined space, such as a garage.
- Disable the AGS feature of an inverter-charger or other automatic starting device before storing the vehicle or parking it in a garage or other confined space.

- The exhaust system must be installed in accordance with the genset Installation Manual.
- Engine cooling air must not be used for heating the vehicle.

## GENERATOR VOLTAGE IS DEADLY

- Disable the automatic genset starting feature (AGS) of an inverter-charger or other automatic starting device before servicing the genset to avoid electric shock from an unexpected start.
- Generator electrical output connections must be made by a trained and experienced electrician in accordance with applicable codes.
- The genset must not be connected to shore power (utility). Back-feed to shore power can cause electrocution and damage to equipment. An approved switching device must be used to prevent interconnections.
- Use caution when working on live electrical equipment. Remove jewelry, make sure clothing and shoes are dry, stand on a dry wooden platform or rubber insulating mat and use tools with insulated handles.

## DIESEL FUEL IS COMBUSTIBLE

- Do not smoke or turn electrical switches ON or OFF where fuel fumes are present or in areas sharing ventilation with fuel tanks or equipment. Keep flames, sparks, pilot lights, arc-producing equipment and all other sources of ignition well away.
- Fuel lines must be secured, free of leaks and separated or shielded from electrical wiring.

## MOVING PARTS CAN CAUSE SEVERE PERSONAL INJURY OR DEATH

- Disable the automatic genset starting feature (AGS) of an inverter-charger or other automatic starting device before servicing the genset to avoid unexpected starting.
- Do not wear loose clothing or jewelry near moving parts such as PTO shafts, fans, belts and pulleys.
- Keep hands away from moving parts.

- Keep guards in place over fans, belts, pulleys, and other moving parts.

### **BATTERY GAS IS EXPLOSIVE**

- Before servicing the batteries, disconnect Shore Power, push the Power Unit circuit breaker OFF and turn the Coach DC Disconnect Switch to Disconnect (to power down the Hybrid Power System).
- Wear safety glasses.
- Do not smoke.
- Remove jewelry.
- Observe proper battery cable connect/disconnect sequences.
- Secure DC terminal protective covers to prevent accidental shorting with metal tools.

### **IMPROPER CHARGING CAN OVERHEAT COACH BATTERIES AND CAUSE FIRE**

Do not mix old and new batteries or different types of batteries. Reconfigure the Hybrid Power System for proper charging if battery type and bank capacity have changed.

### **FLAMMABLE VAPORS CAN CAUSE DIESEL ENGINES TO OVERSPEED**

Do not operate the diesel-powered Hybrid Power System where there are or can be flammable vapors created by fuel spills, gas leaks, etc. Flammable vapors drawn into a diesel engine air intake system can cause the engine to overspeed, which can result in fire, explosion and equipment damage. The owners and operators of the Hybrid Power System are solely responsible for safe operation.

### **COACH ELECTRICAL SYSTEMS CAN IGNITE FLAMMABLE VAPORS**

- Disable AUTO and stop Generator Mode before fueling the coach to reduce the risk of igniting flammable vapors.
- Do not store liquid or gaseous fuel containers in the same enclosures as the Inverter/Chargers, Transfer Switch, batteries or other spark-producing equipment.

### **GENERAL PRECAUTIONS**

- Keep children away from Hybrid Power System components.
- Do not use evaporative starting fluids. They are highly explosive.
- Let the engine cool down before removing the coolant pressure cap or opening the coolant drain. Releasing hot coolant under pressure can lead to severe burns.
- Keep the Hybrid Power System components and their enclosures clean. Oil collects dirt that can restrict cooling. Oily rags can catch fire. Stowed gear can block cooling air.
- Make sure all fasteners are secure and torqued properly.
- Do not perform Hybrid Power System maintenance or service when mentally or physically tired or after consuming alcohol or drugs.
- You must be trained and experienced to make adjustments while the Hybrid Power System is in operation—hot, moving or electrically live parts can cause severe personal injury or death.
- Used engine oil has been identified by some U. S. state and federal agencies as causing cancer or reproductive toxicity. Do not ingest, inhale, or contact used oil or its vapors.
- Ethylene glycol, used as engine antifreeze, is toxic to humans and animals. Clean up spills and dispose of used engine coolant in accordance with local environmental regulations.
- Keep a multi-class ABC fire extinguisher in the vehicle. Class A fires involve ordinary combustible materials such as wood and cloth. Class B fires involve combustible and flammable liquids and gaseous fuels. Class C fires involve live electrical equipment. (ref. NFPA No. 10)
- The Hybrid Power System installation must comply with all applicable local, state and federal codes and regulations.

Engine exhaust gases include CARBON MONOXIDE (CO), an odorless, colorless, poisonous gas that can cause severe personal injury or death. Symptoms of CO poisoning include:

# 1. Introduction

## ABOUT THIS MANUAL

This is the Operator's Manual for the Model HQDSB Hybrid Quiet Diesel Power System (Hybrid Power System), comprised of the following major components:

- Model HQDPB Power Unit
- Model HQDVA Inverter/Charger (Primary)
- Model HQDVB Inverter/Charger (Secondary)
- Model HQDTA Transfer Switch

For specific information about the system and its components, see *Appendix E. Specifications*.

**Note: The Hybrid Power System will not work without these components, nor with substitutes.**

Read and carefully observe all of the instructions and precautions in this manual. Keep this manual with the other coach manuals.

To operate the Hybrid Power System, see *Section 2. Operating the Hybrid Power System*.

The operator is responsible for Power Unit maintenance in accordance with the PERIODIC MAINTENANCE SCHEDULE (p. 3-7) and for battery maintenance in accordance with *Section 6. Coach Batteries*.

To understand and use the Operator Panel and navigate its menus, see *Appendix A. Operator Panel*.

For steps that can be taken to diagnose and correct a problem that causes a warning or shutdown, see *Appendix B. Troubleshooting Symptoms* and *Appendix C. Troubleshooting Fault Codes*.

**⚠ WARNING** *The Hybrid Power System is not for life support. It can stop without warning. Children, persons with physical or mental limitations, and pets could suffer personal injury or death. A personal attendant, redundant power or alarm system must be used if power system operation is critical.*

## HYBRID POWER SYSTEM COMPONENT NAMEPLATES

**⚠ WARNING** *Improper service or replacement of parts can lead to severe personal injury or death and to damage to equipment and property. Service personnel must be qualified to perform electrical and mechanical service.*

**⚠ CAUTION** *Unauthorized modifications or replacement of fuel, exhaust, air intake or speed control system components that affect engine emissions are prohibited by law in the State of California.*

Be ready to provide the model, spec and serial numbers on the component nameplates when contacting Cummins Onan for information, parts and service. Figure 1-1 illustrates the nameplates and their locations.

Record these numbers in Table 1-1 so that they are easy to find when needed. Each character in these numbers is significant for obtaining the right parts listed in the Parts Catalog. Genuine Cummins Onan replacement parts are recommended for best results.

TABLE 1-1. COMPONENT MODEL AND SERIAL NUMBERS

|                                    | MODEL/SPEC NUMBER | SERIAL NUMBER |
|------------------------------------|-------------------|---------------|
| POWER UNIT                         |                   |               |
| TRANSFER SWITCH                    |                   |               |
| PRIMARY INVERTER/CHARGER (HQDVA)   |                   |               |
| SECONDARY INVERTER/CHARGER (HQDVB) |                   |               |



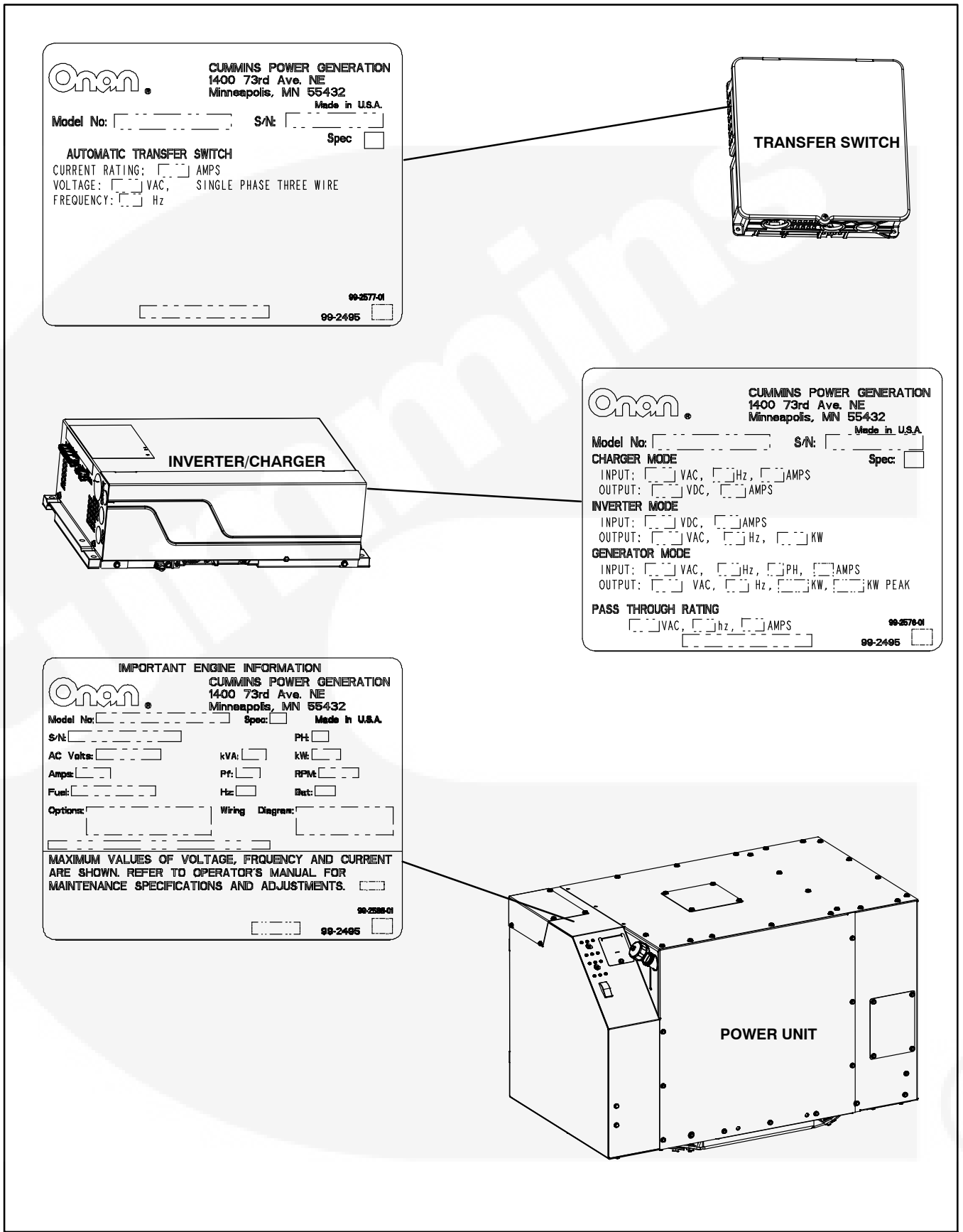

FIGURE 1-1. COMPONENT NAMEPLATES AND THEIR LOCATIONS

## HOW TO OBTAIN SERVICE

For parts, service, and product information (such as the Service Manual), contact the nearest authorized Cummins Onan distributor. You may go to Web site [www.cumminsonan.com](http://www.cumminsonan.com) for information on contacting our distributors worldwide.

### In North America

Call 1-800-888-6626 to contact the nearest Cummins Onan distributor in the United States or Canada. If you are unable to contact a distributor using the automated service, consult the Yellow Pages. Typically, our distributors are listed under:

GENERATORS  
- ELECTRIC

ENGINES  
- GASOLINE OR DIESEL

RECREATIONAL VEHICLES  
- EQUIPMENT, PARTS AND SERVICE

If you have difficulty arranging service or resolving a problem, please contact the Service Manager at the nearest Cummins Onan distributor for assistance.

### Outside North America

If you are outside North America, call Cummins Onan at 1-763-574-5000 from 7:30 AM to 4:00 PM, Central Standard Time, Monday through Friday, or fax 1-763-528-7229.

### Information to Have Ready

Before calling for service, have the following information available:

1. Complete model number and serial number (p. 1-1)
2. Date of purchase
3. Nature of problem

## ENGINE EMISSIONS COMPLIANCE

The label that states compliance with applicable engine emissions regulations is located on the side of the Power Unit, as shown circled in Figure 1-2. Refer also to the FEDERAL EMISSION DESIGN AND DEFECT LIMITED WARRANTY FOR C. I. ENGINES (DIESELS) that is part of the same package as this manual.

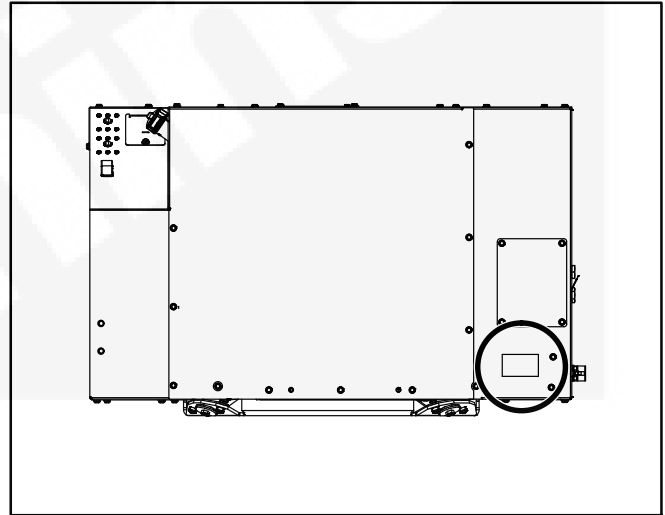

FIGURE 1-2. EMISSIONS LABEL LOCATION

## FEATURES

The Hybrid Power System components are integrated with Shore Power and the Coach Batteries to comprise a complete Coach AC power supply system. The Operator Panel is used to monitor, control and configure the integrated power supply system.

The Hybrid Power System has the following features:

- Automatic Power Unit operation
- Battery boost when transients or short term loads (air conditioners) exceed Power Unit capacity
- Battery charge shedding under high AC load conditions
- Accurate battery state of charge (SOC) monitoring based on battery temperature, current and voltage
- Battery charging at up to 140 amps DC in Model 1215 HQDSB systems, or up to 280 amps DC in Model 1218 HQDSB systems
- Power factor correction when charging
- Shore power quality monitoring
- Built-in system diagnostics



## MODES OF OPERATION

### Modes of Operation

The Hybrid Power System has three modes of operation:

- Generator Mode
- Inverter Mode
- Shore Power Mode

### Generator Mode

Power flows from the Power Unit to the two Inverter/Chargers (one shown). The Inverter/Chargers con-

vert the dual 3-phase, variable-voltage, variable-frequency output of the Power Unit into single-phase, 120/240 volt, 60 Hertz AC power. During power boost to start loads such as air conditioners, the Inverter/Chargers also convert 12 volt DC from the coach batteries into single-phase, 120/240 volt, 60 Hertz AC power to supplement output from the Power Unit. The Transfer Switch connects the incoming power from the Inverter/Chargers to the main AC distribution panel to supply all coach appliances, lights, power outlets and air conditioners.

While supplying the AC loads, the Inverter/Chargers also recharge the coach batteries with any power still available from the Power Unit.

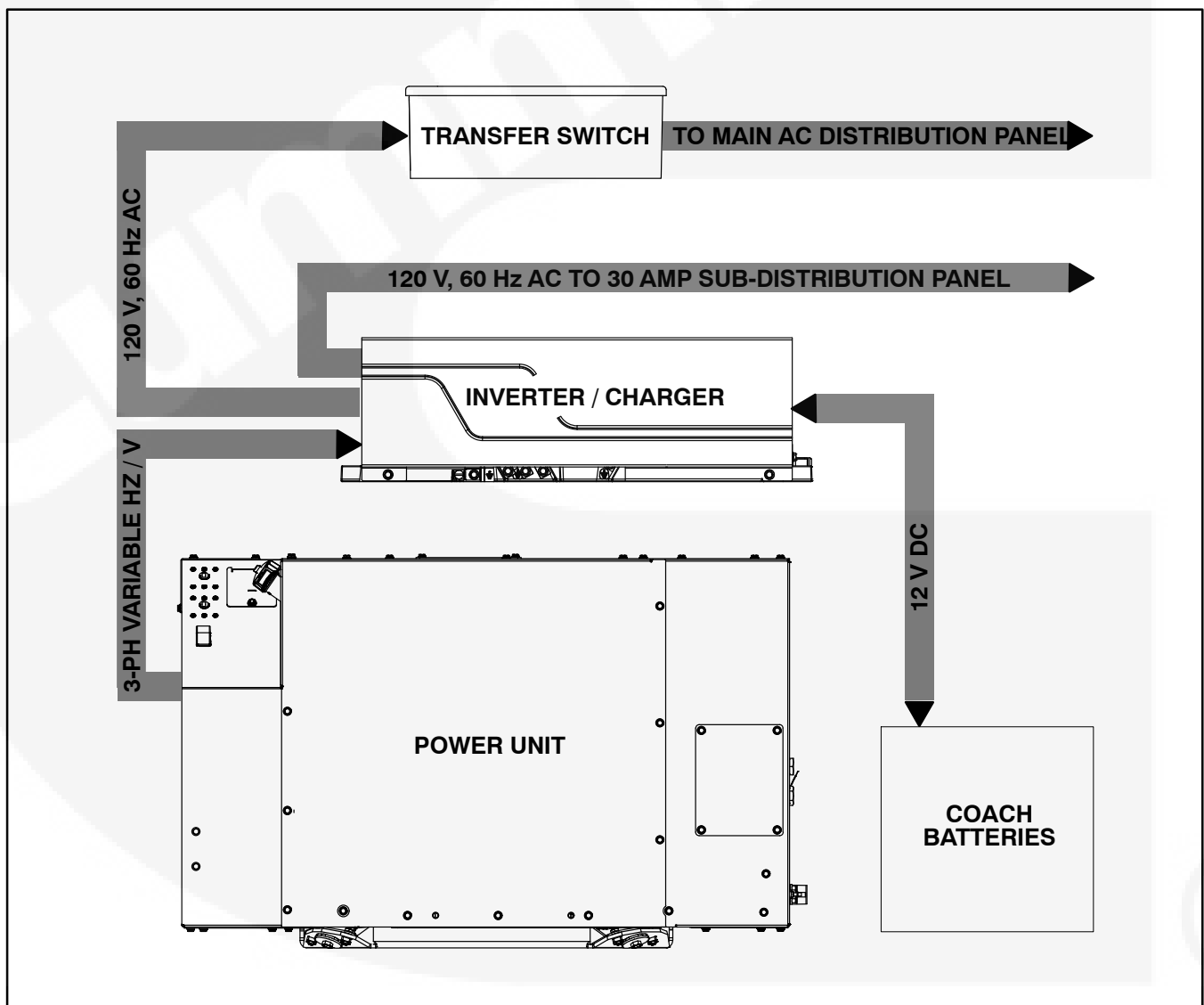

FIGURE 1-3. GENERATOR MODE

## Inverter Mode

Power flows from the coach batteries to the two Inverter/Chargers (one shown). The Inverter/Chargers convert 12 volt DC into 120 volt, 60 Hertz AC power, which is distributed by two AC sub-distribu-

tion panels to most of the coach appliances, lights and power outlets. (In Model 1215 HQDSB systems only the Primary Inverter/Charger inverts battery power.)

Inverting stops when battery charge is drawn down to a preset low battery level.

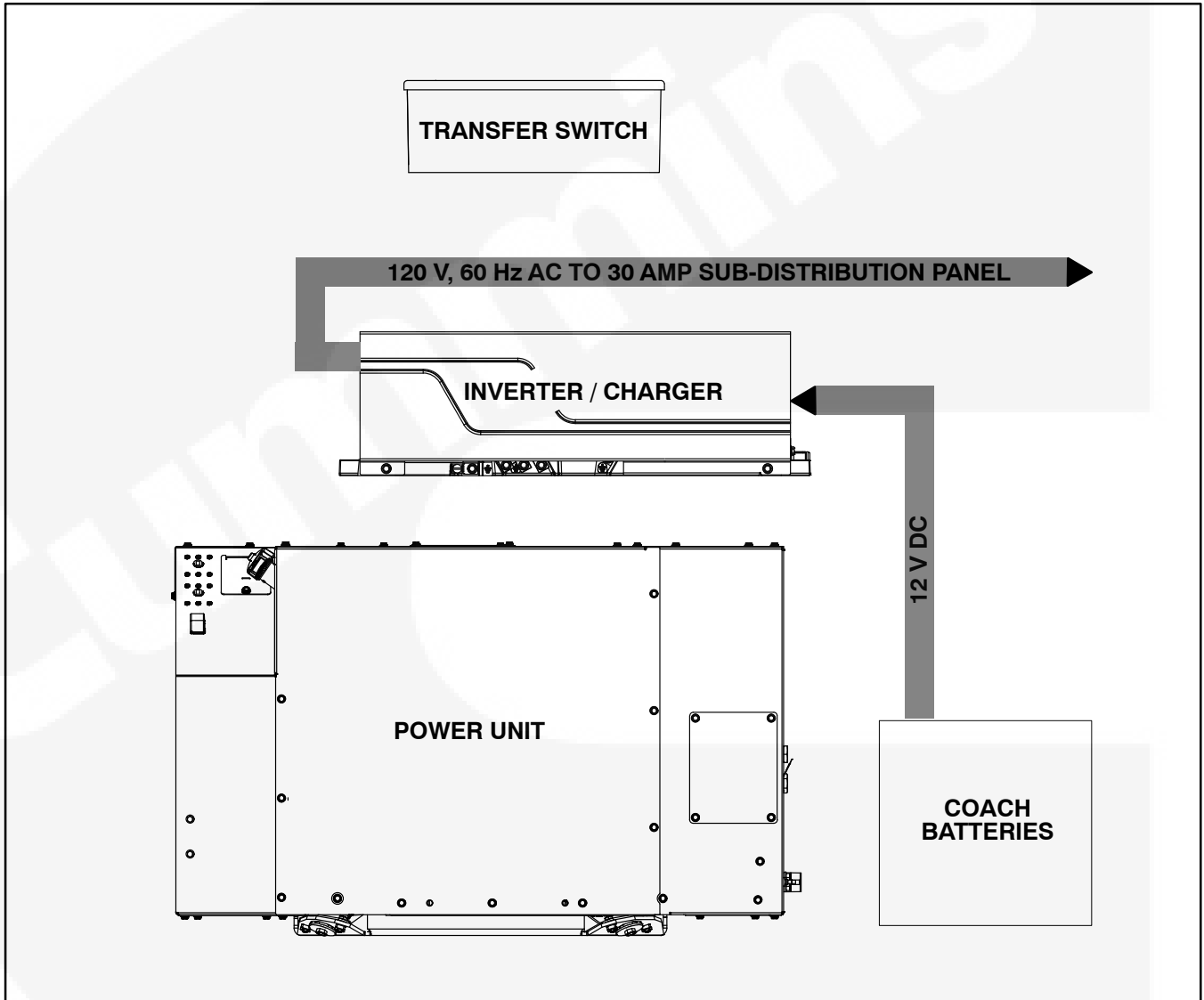

FIGURE 1-4. INVERTER MODE

## Shore Power Mode

The Transfer Switch senses when the coach is connected to shore power. Unless the Hybrid Power System is in Generator Mode, the Transfer Switch connects the incoming shore power to the main AC

distribution panel to supply all coach appliances, lights, power outlets and air conditioners.

While shore power is supplying the AC loads, the two Inverter/Chargers also recharge the coach batteries with any power still available from Shore Power. (In Model 1215 HQDSB systems only the Primary Inverter/Charger charges the batteries.)

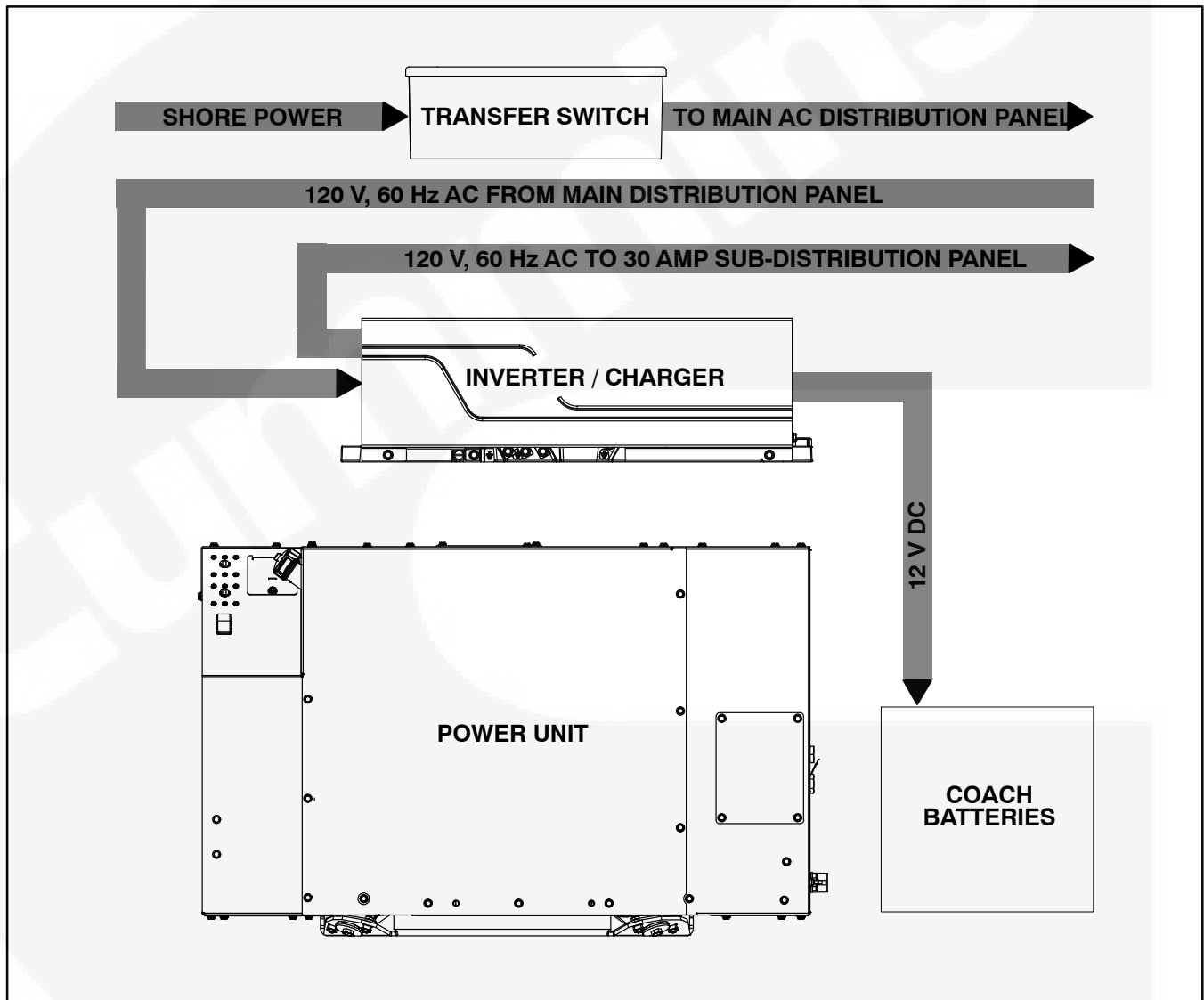
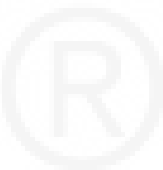

FIGURE 1-5. SHORE POWER MODE



**THIS PAGE LEFT INTENTIONALLY BLANK**



## 2. Operating the Hybrid Power System

---

**⚠WARNING** *ENGINE EXHAUST IS DEADLY. Engine exhaust gases include CARBON MONOXIDE (CO), an odorless, colorless, poisonous gas that can cause severe personal injury or death. Symptoms of CO poisoning include:*

- *Dizziness, Headache or Throbbing Temples*
- *Weakness or Muscular Twitching*
- *Sleepiness or Confusion*
- *Nausea or Vomiting*

**IF YOU OR ANYONE ELSE EXPERIENCES ANY OF THESE SYMPTOMS, GET OUT INTO FRESH AIR IMMEDIATELY.**

- *Get advice from 911, poison control or a medical center.*
- *Do not enable AUTO or start Generator Mode until the exhaust system has been repaired. Exhaust system installation must be in accordance with the Hybrid Power System Installation Manual.*
- *Do not enable AUTO or start Generator Mode before going to sleep unless the coach has working CO detectors.*
- *Do not enable AUTO or start Generator Mode unless the coach is out in fresh, open air.*
- *Disable AUTO and stop Generator Mode when parking the coach in a garage or other confined space.*

**⚠WARNING** *Disable AUTO and stop Generator Mode before fueling the coach to prevent ignition of flammable vapors.*

### PRE-START CHECKS

Before the first start of the day and after every eight hours of operation in Generator Mode, inspect the Power Unit as instructed under GENERAL INSPECTIONS (p. 3-8). Also make sure that all carbon monoxide (CO) detectors are working.

### EVERYDAY OPERATION

The Hybrid Power System is designed for AUTO operation. When AUTO is enabled, power is supplied in Generator, Inverter or Shore Power Mode, as appropriate. AUTO is disabled each time you park or move the coach. This gives YOU the opportunity to confirm that AUTO operation is safe under the conditions.

When you park the coach at a new site you will have to decide about:

- Enabling AUTO (p. 2-2)
- Manually controlling Inverter Mode (p. 2-4)
- Manually controlling Generator Mode (p. 2-5)
- Connecting Shore Power (p. 2-6)

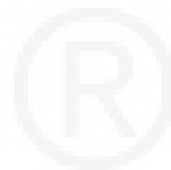



## ENABLING AUTO

To enable AUTO confirm that it is safe to do so and then press **Auto** (Figure 2-1).

**Note:** See Page A-27 if either of these two prompts appear: “Auto Mode Expires in (5, 4, 3, 2, or 1) days” or “Safety Input Expired.”

### Quiet Time

Note the Quiet Times displayed on the CONFIRM AUTO screen. Reset and enable/disable as necessary (p. A-5). Then select CONFIRM AUTO and press **OK**.

### Current Time

If the time zone has changed, press **Clock** to reset (p. A-6). Otherwise, Quiet Time will start and end earlier or later than expected.

### Normal Operation

When you press **OK** the Auto and Inverter lights come on and power becomes available right away for most coach appliances, lights and power outlets.

From time to time the Inverter light will go out and the Generator light will come on, indicating that AUTO has switched to Generator Mode to recharge the coach batteries or power the air conditioners. You should hear the Power Unit engine crank, start and run.

Once the batteries have been recharged and the air conditioners have cycle off, AUTO switches operation back to Inverter Mode. AUTO switching from Inverter Mode to Generator Mode and back again takes place without power interruption.

If Quiet Time has been enabled, AUTO will switch to Generator Mode as far ahead of time as necessary (could be several hours) to fully charge the batteries for the upcoming Quiet Time.

See Page 6-1 about battery charging and go to Battery Status (p. A-9) to find out how many hours it will take.

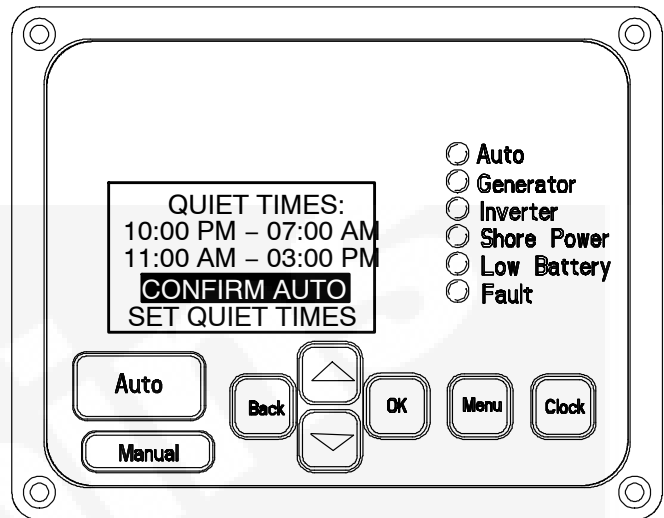

FIGURE 2-1. CONFIRM AUTO SCREEN

## Generator Mode Screen

When the Generator light comes on, the home screen displays AC voltage, the current in each line and the state of charge of the coach batteries (Figure 2-2). The arrow in the battery icon points up when the coach batteries are being charged and down when they are being discharged to provide boost for starting loads such as the air conditioners.

## Inverter Mode Screen

When the Inverter light comes on, the Inverter Mode screen displays AC voltage and current output from each Inverter/Charger (Line 1 and Line 2) and the state of charge of the coach batteries (Figure 2-3). The arrow in the battery icon points down because the coach batteries are being discharged as power flows from them.

Press **Menu** for more information about the status of the Hybrid Power System. See Page A-8.

## Moving the Coach

To prevent disruption of Generator Mode when it is time to move the coach (turning the ignition key or releasing the parking brake disables AUTO), first exit AUTO. To do this, press **Manual**, select EXIT AUTO MODE (Figure 2-4) and press **OK**. Generator Mode will stay on while driving until manually turned OFF.

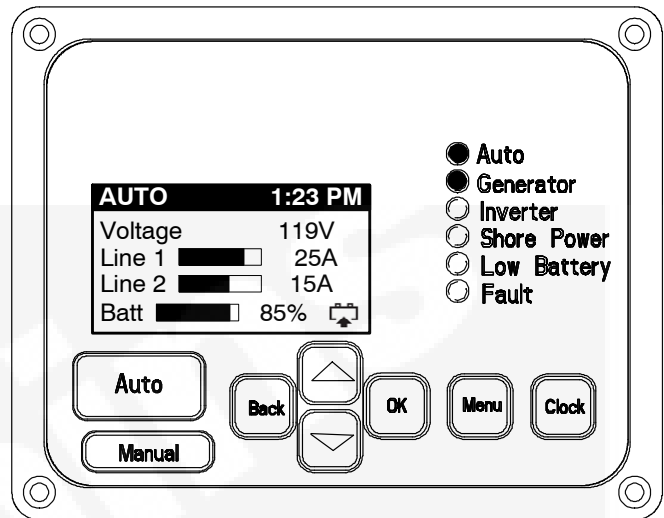

FIGURE 2-2. TYPICAL GENERATOR MODE SCREEN

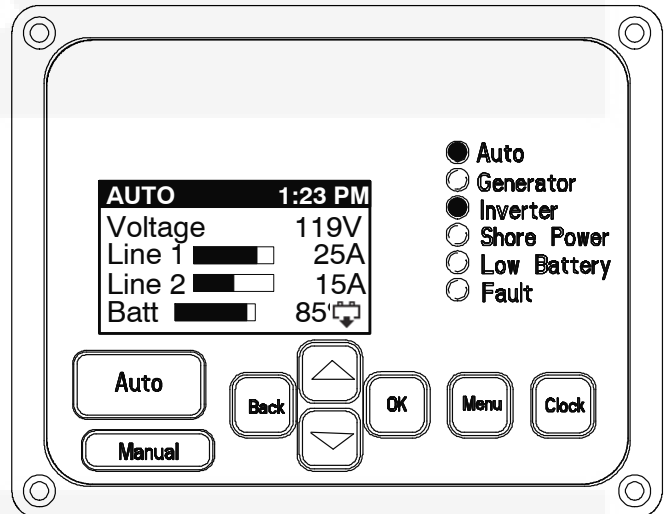

FIGURE 2-3. TYPICAL INVERTER MODE SCREEN

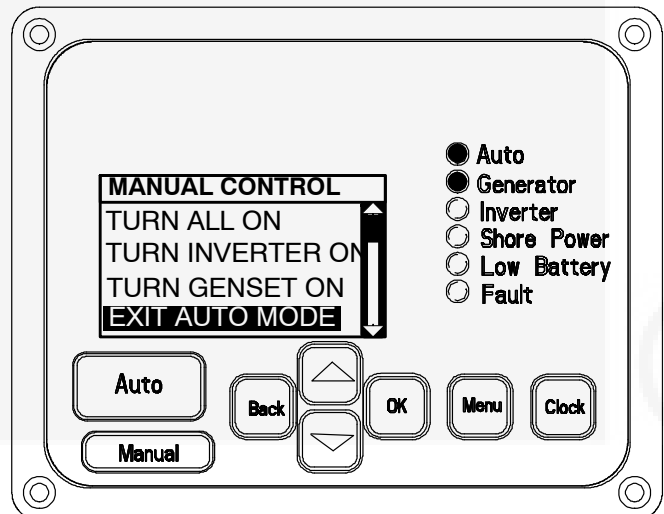

FIGURE 2-4. EXIT AUTO MODE SCREEN

## INVERTER MODE—MANUAL CONTROL

You may want to start Inverter Mode if the coach batteries have been recharged but shore power is not available and engine noise or the possible hazard of CO is a concern.

### Starting Inverter Mode

To start Inverter Mode, press **Manual**, select **TURN INVERTER ON** (Figure 2-5) and press **OK**.

### Normal Operation

When you press **OK**, the Inverter light comes on and power becomes available right away for most coach appliances, lights and power outlets. If the Low Battery light comes on, power will be available for a limited time. Go to the Battery Status screen (p. A-9) to find out how many hours are left at current usage. You may have to reduce the number of appliances being used during the time Generator Mode and Shore Power Mode are not available.

### Inverter Mode Screen

When the Inverter light comes on, the Inverter Mode screen displays AC voltage and current output from each Inverter/Charger (Line 1 and Line 2) and the state of charge of the coach batteries (Figure 2-3). The arrow in the battery icon points down because the coach batteries are being discharged as power flows from them.

Press **Menu** for more information about the status of the Hybrid Power System. See Page A-8.

### Stopping Inverter Mode

To stop Inverter Mode, press **Manual**, select **TURN INVERTER OFF** and press **OK**.

### When Generator or Shore Power Mode Becomes Available

Switching to Generator Mode or to Shore Power Mode from Inverter Mode takes place without power interruption.

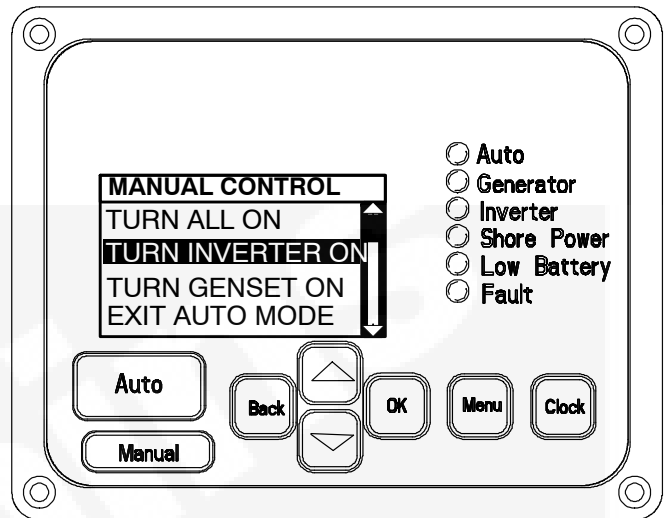

FIGURE 2-5. MANUAL CONTROL SCREEN

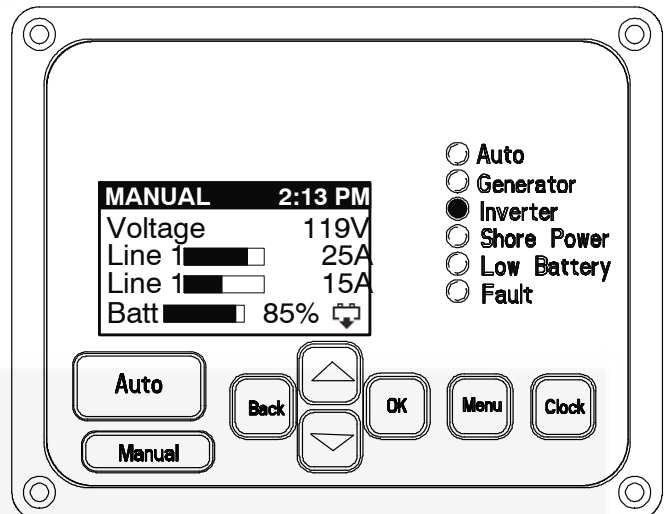

FIGURE 2-6. MANUAL INVERTER MODE SCREEN

## GENERATOR MODE—MANUAL CONTROL

You will have occasions to start Generator Mode, such as to exercise the Power Unit when use is infrequent.

**Make sure it is safe to start Generator Mode. Review WARNINGS and PRE-START CHECKS on Page 2-1.**

### Starting Generator Mode

To start Generator Mode, first confirm that it is safe to do so, press **Manual**, select **TURN GENSET ON** (Figure 2-7) and press **OK**.

### Normal Operation

When you press **OK** there will be a delay of up to 20 seconds for engine pre-heating before you hear the Power Unit engine crank, start and run.

The Generator light comes on and power becomes available for to all coach appliances, lights, power outlets and air conditioners after the Power Unit has warmed up for 30 seconds.

Generator Mode also recharges the coach batteries. See Page 6-1 about battery charging and go to Battery Status (p. A-9) to find out how many hours of it will take.

### Generator Mode Screen

The Generator Mode screen displays AC voltage, the current in each line and the state of charge of the coach batteries (Figure 2-8). The arrow in the battery icon points up when the coach batteries are being charged and down when they are being discharged to provide boost for starting loads such as the air conditioners.

Press **Menu** for more information about the status of the Hybrid Power System. See Page A-8.

### Stopping Generator Mode

To stop Generator Mode, press **Manual**, select **TURN GENSET OFF** and press **OK**.

**Note:** If **AUTO** is enabled while Generator Mode is under manual control, **AUTO** will turn off Generator Mode in 15 minutes unless the coach batteries are being charged or the air conditioners are running.

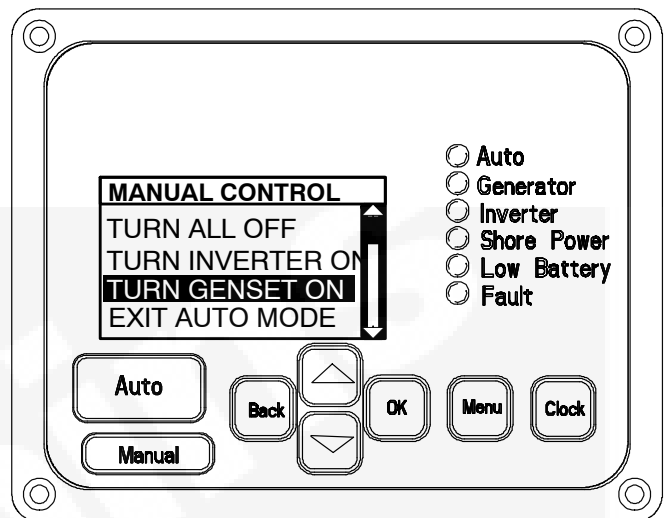

FIGURE 2-7. MANUAL CONTROL SCREEN

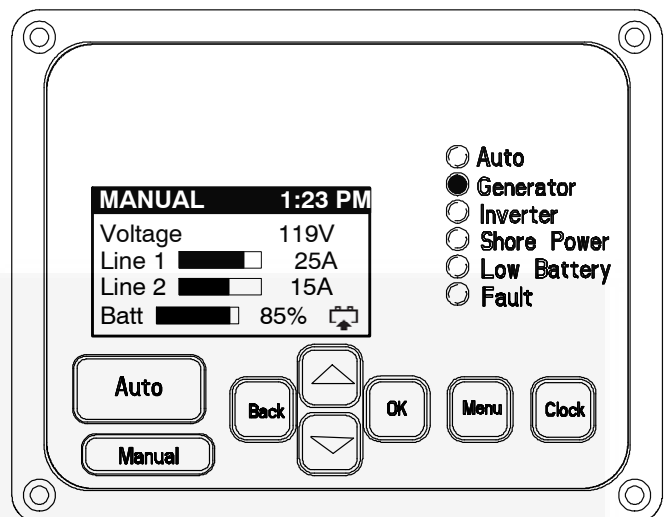

FIGURE 2-8. MANUAL GENERATOR MODE SCREEN

## SHORE POWER MODE

### Connecting Shore Power

If shore power is available, decide whether to connect. If you decide to connect, you will need to obtain an adapter plug if the shore power receptacle does not mate with the 50 amp coach plug.

### Normal Operation

The Shore Power light comes on a few seconds after you connect shore power and then power becomes available for all coach appliances, lights, power outlets and air conditioners.

Shore Power Mode also recharges the coach batteries. See Page 6-1 about battery charging and go to Battery Status (p. A-9) to find out how many hours it will take.

### Shore Power Detected Screen

Once the coach is connected to shore power, go to the Operator Panel. Normally, the Shore Power Detected screen appears (Figure 2-9). See Page A-25 if the Shore Quality Warning screen appears.

### Resetting Breaker Size

If you connected the coach to a shore power service of less than 30 amps, it is recommended that you reset Breaker Size. Press the up and down arrows to select Breaker Size and then press OK.

See Page A-17 to change Breaker Size if the Operator Panel has already switched to the home screen.

### Shore Power Screen

The Shore Power screen displays after 10 minutes (Figure 2-10). It displays shore power voltage, the current in each line and the state of charge of the coach batteries. The arrow in the battery icon points up when the coach batteries are being charged.

Press **Menu** for more information about the status of the Hybrid Power System. See Page A-8.

### Starting Generator Mode

If Generator Mode is started, the coach loads will be switched from Shore Power to Generator Mode without power interruption

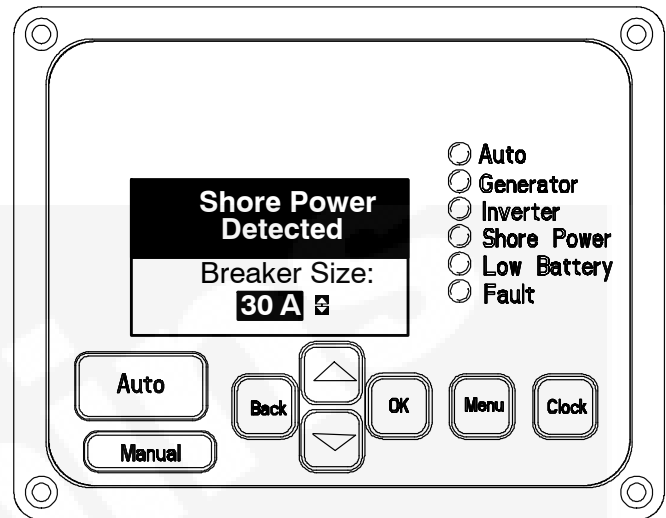

FIGURE 2-9. SHORE POWER DETECTED PROMPT

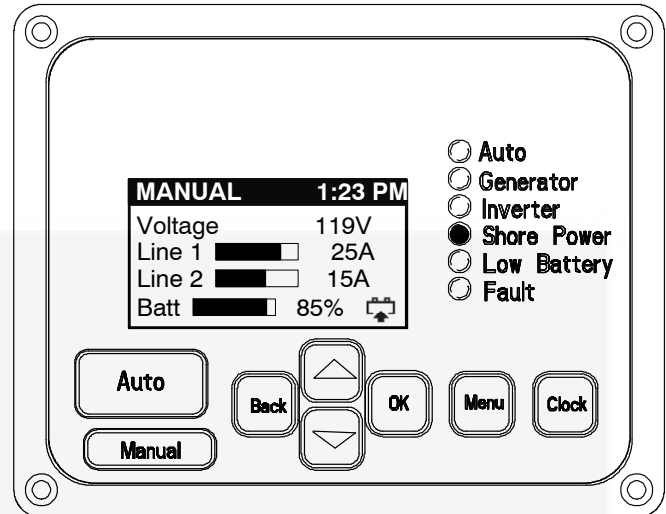

FIGURE 2-10. TYPICAL SHORE POWER SCREEN

# 3. Power Unit Operation and Maintenance

## GENERAL

The Power Unit (Figure 3-1) is the source of power in Generator Mode. It has a permanent magnet alternator driven by a diesel engine. Its two 3-phase outputs vary in frequency and voltage as load varies. Two Inverter/Chargers (primary and secondary) convert the two Power Unit outputs into usable 60 Hz, 240/120 volt AC, and into 12 volt DC for battery charging.

**⚠WARNING** *Do not connect the Power Unit to the Coach AC circuits. Its high output voltages can damage equipment and cause death or severe personal injury.*

The Power Unit has a microprocessor that communicates with microprocessors in the Inverter/Chargers, Transfer Switch and Operator Panel, providing an integrated control and monitoring system with built-in system diagnostics.

This Section covers operation and maintenance of the Power Unit as part of the Hybrid Power System. The operator is responsible for performing maintenance in accordance with the PERIODIC MAINTENANCE SCHEDULE (p. 3-7).

See *Section E. Specifications* for Power Unit ratings and specifications.

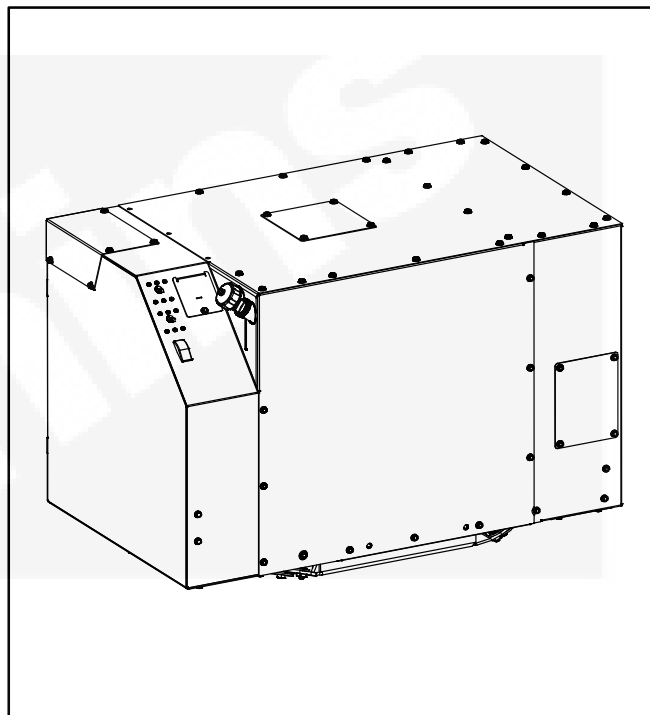
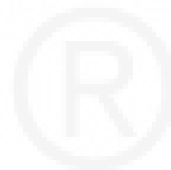

FIGURE 3-1. POWER UNIT



## POWER UNIT CONTROL PANEL

The Power Unit control panel (Figure 3-2) has the following features:

### Control Switch

**Make sure it is safe to start Generator Mode. Review WARNINGS and PRE-START CHECKS on Page 2-1.**

This switch is used to:

- Manually Start the Power Unit. Starting places the Hybrid Power System in Generator Mode. Press and hold START until the engine starts. Cranking may be delayed up to 20 seconds while the glow plugs pre-heat the engine combustion chambers.
- Manually Stop the Power Unit. Touch Stop to cause the Power Unit to stop.
- Prime the engine fuel system. Press and hold PRIME as long as necessary to prime the fuel system. (Priming starts in 2 seconds.)
- Fill the Inverter/Charger cooling system. Press and hold PRIME for up to 10 seconds. The coolant pump starts in 2 seconds and stops in 2 minutes.

**Note: Compare control switch functions with the Operator Panel AUTO (p. A-3) and MANUAL (p. A-7) functions.**

### Status Light

The status light is part of the control switch.

- It flashes rapidly to indicate that preheat and cranking are taking place. Flashing before cranking starts indicates that the glow plugs are preheating the engine combustion chambers. The time varies based on engine temperature.
- It stays on to indicate that the Power Unit is running.
- It flashes the numerical fault shutdown codes. See *Appendix C. Troubleshooting Fault Codes*. See FAULT INFORMATION (p. A-14) to display fault history on the Operator Panel.

- It flashes slowly when PRIME is pressed and held for up to 10 seconds. It will continue to flash slowly for 2 minutes indicating that the Inverter/Charger coolant pump is running.
- It flashes rapidly when PRIME is pressed and held longer than 10 seconds, indicating that fuel is being primed.

### Circuit Breakers

These circuit breakers protect the 3-phase AC leads between the Power Unit and Inverter/Chargers from overcurrent and short circuits.

### Inverter/Charger Coolant Fill Cap

This cap is on the internal tank that serves as the reservoir for Inverter/Charger coolant. It is also the recovery tank for engine coolant. Replenish the normal loss of engine and Inverter/Charger coolant by filling here.

### Engine Coolant Pressure Cap

The engine coolant pressure cap is accessible by removing the access plate on the control panel. Fill coolant here when refilling the engine cooling system.

### Oil Fill Cap and Dip Stick

The oil dipstick is attached to the fill cap and is marked ADD and FULL.

## REMOTE CONTROL SWITCH

**Make sure it is safe to start Generator Mode. Review WARNINGS and PRE-START CHECKS on Page 2-1.**

A remote control switch may be located on the coach dash board. It functions the same way as the control switch on the Power Unit control panel. It may or may not incorporate a flashing status light.

Starting the Power Unit with this switch places the Hybrid Power System in Generator Mode.

**Note: Compare remote control switch functions with the Operator Panel AUTO (p. A-3) and MANUAL (p. A-7) functions.**

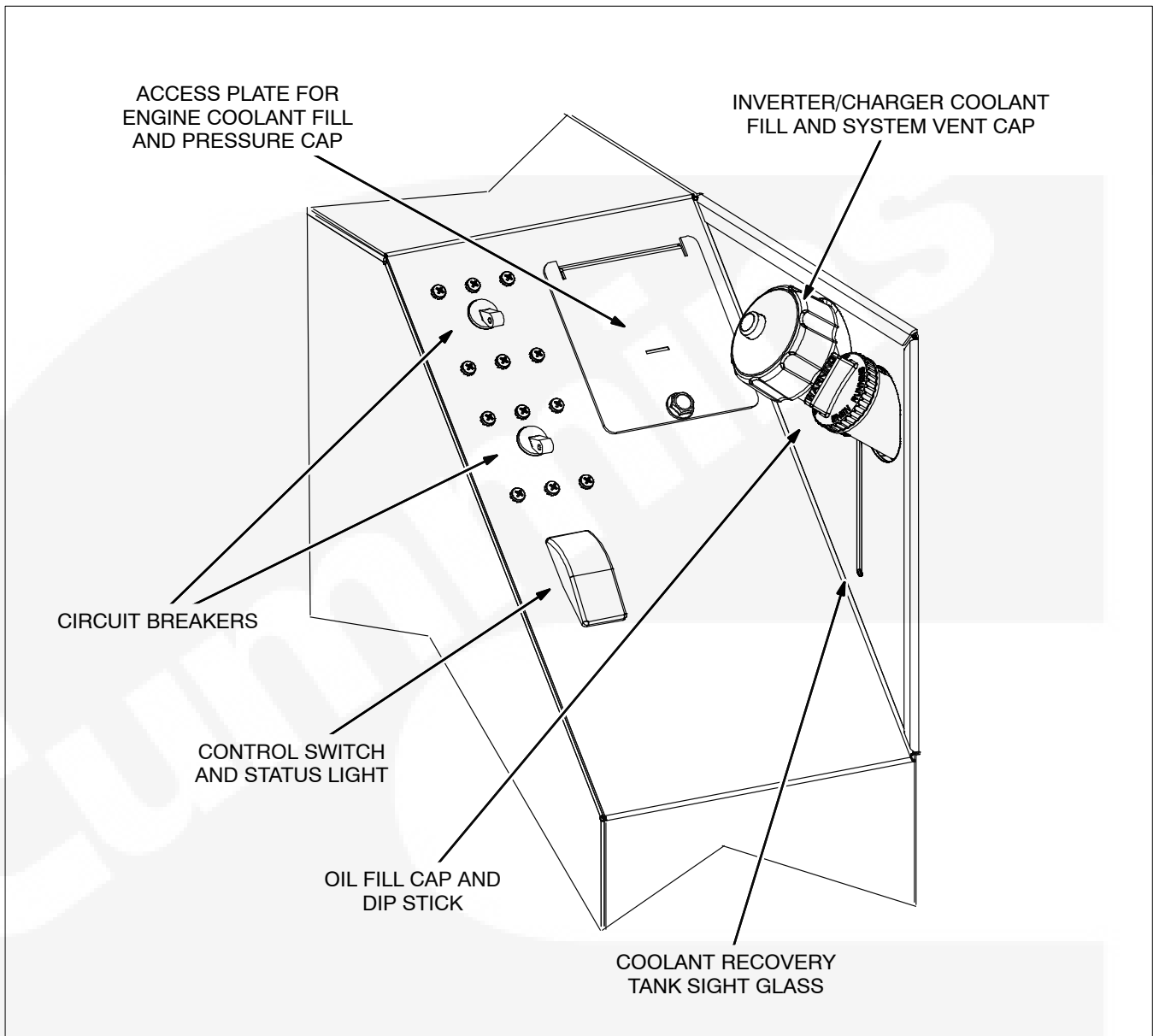

**FIGURE 3-2. POWER UNIT CONTROL PANEL**



## RECOMMENDED FUEL

**⚠WARNING** *Diesel fuel is combustible and can cause severe personal injury or death. Do not smoke near fuel tanks or fuel-burning equipment or in areas sharing ventilation with such equipment. Keep flames, sparks, pilot flames, electrical arcs and switches and all other sources of ignition well away. Keep a multi-class ABC fire extinguisher handy.*

High quality diesel fuel is necessary for good performance and long engine life.

- The specifications for the type and sulfur content (ppm, % weight) of the diesel fuel used must comply with all emissions regulations applicable in the areas where the genset is to be operated.
- Diesel fuels meeting ASTM D975 or EN 590 specifications are recommended. Use Grade 1-D diesel fuel where ambient temperatures are below 14° F (–10° C). A minimum Fuel Cetane Rating of 45 is recommended. Where ambient temperatures are below –4 F (–20° C), or the elevation is above 5000 ft (1500 m), a minimum Cetane Rating of 50 is recommended.
- Current US EPA regulations for Non-Road engines limit diesel fuel sulfur content to a maximum of 500 ppm (0.05% weight). Therefore, use Grade 2-D S500 or 2-D S15 diesel fuel. Where ambient temperatures are below 14° F (–10° C), use Grade 1-D S500 or 1-D S15 die-

sel fuel. Note that beginning in year 2010, US EPA regulations for Non-Road engines will limit diesel fuel sulfur content to a maximum of 15 ppm (0.0015% weight).

- Do not use diesel fuel having a sulfur content greater than 10,000 ppm (1.0% weight).
- Diesel fuel must meet the ASTM D975 standard for lubricity and pass a minimum load level of 3100 grams as measured by ASTM D6078, or maximum scar diameter of 0.45 mm as measured by ASTM D6079 or ISO 12156–1.
- B5 Bio-Diesel fuel that meets industry specifications and quality is suitable for use with this genset.

## RECOMMENDED COOLANT

Use the best quality ethylene glycol antifreeze solution available for engine and Inverter/Charger cooling systems. It should be fully formulated with rust inhibitors and coolant stabilizers. Use fresh water that is low in minerals and corrosive chemicals. Distilled water is best.

See *Section E. Specifications* for engine cooling system capacity.

**Note:** *If the Power Unit and Inverter/Chargers are located at opposite ends of the coach, it could take up to 2 gallons (8 liters) of coolant to fill the system because of the long length of the supply and return hoses between the Power Unit and Inverter/Chargers.*

## RECOMMENDED ENGINE OIL

### Oil Performance Class

Use API (American Petroleum Institute) classified engine oils according to the following guidelines:

- **Emissions-Regulated Areas:** It is mandatory to use CF, CF-4, CG-4, CH-4 or CI-4 class oil with low sulfur fuel (sulfur content less than 500 ppm, 0.05% weight) or ultra low sulfur fuel (sulfur content less than 15 ppm, 0.0015% weight).
- **Non-Regulated Areas:** CF class oil is recommended when using high sulfur fuel—sulfur content between 500 ppm (0.05% weight) and 5000 ppm (0.5% weight). If CF-4, CG-4, CH-4 or CI-4 class oil is used, the oil and oil filter must be changed twice as often as specified in the PERIODIC MAINTENANCE SCHEDULE (Page 3-7).
- **Non-Regulated Areas:** Use CF, CF-4, CG-4, CH-4 or CI-4 class oil when using high sulfur fuel—sulfur content between 5000 ppm (0.5% weight) and 10,000 ppm (1.0% weight). The oil and oil filter must be changed twice as often as specified in the PERIODIC MAINTENANCE SCHEDULE (Page 3-7).

### Oil Viscosity

Look for the SAE (Society of Automotive Engineers) viscosity grade. Referring to Figure 3-3, choose the viscosity grade appropriate for the ambient temperatures expected until the next scheduled oil change. Multi-grade oils such as SAE 15W-40 are recommended for year-round use.

See Section E. Specifications for oil capacity.

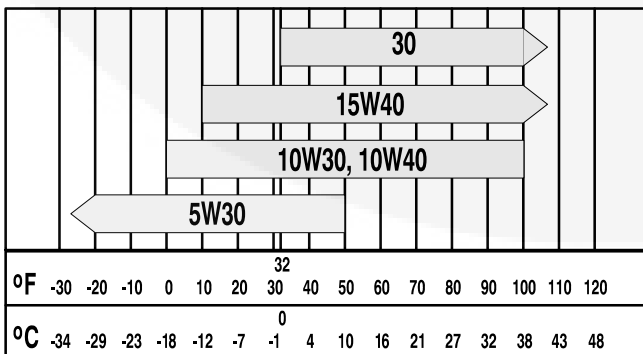

FIGURE 3-3. OIL VISCOSITY VS. TEMPERATURE

## OPERATING AT HIGH ALTITUDE

Maximum power decreases as altitude increases because air density decreases. For every 1000-foot (305 m) increase in elevation you can expect power to decrease approximately 3.5 percent. Table 3-1 shows the results of typical calculations. ***It may be necessary to run fewer appliances at higher altitudes.***

TABLE 3-1. POWER VS. ALTITUDE

| Elevation above Sea Level | Maximum Power                              |
|---------------------------|--|
| at/below 500 ft (152 m)   | 12,000 W (rated)                           |
| at 2500 ft (762 m)        | 11,620 W                                   |
| at 5500 ft (1676 m)       | 10,300 W                                   |
| above 5500 ft (1676 m)    | 10,300 W minus 420 W every 1000 ft (305 m) |

### OPERATING IN COLD WEATHER

Make sure the engine oil viscosity is appropriate for the cold weather temperatures. See RECOMMENDED ENGINE OIL (Page 3-5). Be sure to change the oil if a sudden drop in temperature occurs.

### OPERATING IN HOT WEATHER

Pay particular attention to the following items when operating in hot weather:

1. Make sure nothing blocks airflow to and from the Power Unit.
2. Make sure engine oil viscosity is appropriate for the ambient temperatures. See RECOMMENDED ENGINE OIL (Page 3-5).
3. Keep the Power Unit clean.
4. Perform maintenance due. See PERIODIC MAINTENANCE SCHEDULE (Page 3-7).

### OPERATING IN DUSTY ENVIRONMENTS

Pay particular attention to the following items when operating in dusty environments:

1. Do not let dirt and debris accumulate inside the Power Unit compartment. Keep the Power Unit clean.
2. Perform air cleaner maintenance more often. See PERIODIC MAINTENANCE SCHEDULE (Page 3-7).
3. Change engine oil more often. See PERIODIC MAINTENANCE SCHEDULE (Page 3-7).

4. Keep containers of engine oil that have been opened tightly closed to keep out dust.

## NEW ENGINE BREAK-IN

Proper engine break-in on a new Power Unit or on one with a rebuilt engine is essential for top engine performance and acceptable oil consumption. To do this:

1. Turn on Generator Mode (p. A-7).
2. Go to the GEN STATUS screen (p. A-11) to monitor engine speed.
3. Turn on enough coach loads to raise engine speed to approximately 1800 RPM (1/2 load) and run for two hours.
4. Add more loads to raise engine speed to approximately 2200 RPM (3/4 load) and run for another two hours.

Proper engine oil and oil level are especially critical during break-in because of the higher engine temperatures that can be expected. Change the oil if not appropriate for the ambient temperatures during break-in. See RECOMMENDED ENGINE OIL (Page 3-5). Check oil level twice a day or every 4 hours during the first 24 hours of operation and change the oil and oil filter after the first 50 hours of operation.

## EXERCISING THE HYBRID POWER SYSTEM

Exercise the Hybrid Power System at least 2 hours every month if use is infrequent. To do this:

1. Turn on Generator Mode (p. A-7).
2. Verify that the Generator light on the Operator Panel is on, indicating that the system is operating and that the Transfer Switch has switched to Generator Mode.
3. Go to the GEN STATUS screen (p. A-11) to monitor engine speed.
4. Turn on enough coach loads to raise engine speed to approximately 1800 RPM (1/2 load) and run for two hours.
5. Turn off the coach loads, turn off Generator Mode and plug in Shore Power. Verify that the Shore Power light on the Operator Panel comes on, indicating that the Transfer Switch has switched to Shore Power Mode.

A single two hour exercise period is better than several shorter periods.

Exercising the Power Unit drives off moisture, re-lubricates the engine, replaces stale fuel and removes oxides from electrical contacts. The result is better starting, more reliable operation and longer engine life.

## STORAGE

When preparing the coach for off-season storage (120 days or more) proper steps must be taken to preserve top Power Unit performance and reliability.

**⚠WARNING** ***CARBON MONOXIDE is deadly and can accumulate to dangerous levels in garages and other confined spaces. AUTO mode must be disabled when storing the coach.***

### Storing the Power Unit

1. Change engine oil and attach a tag indicating oil viscosity. See RECOMMENDED ENGINE OIL (Page 3-5).
2. Plug the exhaust tail pipe to keep out dirt, moisture, bugs, etc.
3. Close the fuel supply valve (if so equipped).
4. Turn the Coach DC Disconnect Switch (p. 6-2) to its DISCONNECT position to disable AUTO and power down the Hybrid Power System to save the coach batteries. It is recommended that the batteries stay connected. See STORING COACH BATTERIES (p. 6-2).

### Returning the Power Unit to Service

1. Check the oil tag on the Power Unit and change oil if the viscosity indicated is not appropriate for the temperatures expected. See RECOMMENDED ENGINE OIL (Page 3-5).
2. Remove the plug from the exhaust tailpipe.
3. Change the air filter element if it is dirty (Page 3-11).
4. Open the fuel supply valve (if so equipped).
5. Turn the Coach DC Disconnect Switch to its CONNECT position (p. 6-2).
6. Inspect the Power Unit. See GENERAL INSPECTIONS (Page 3-8).

## PERIODIC MAINTENANCE SCHEDULE

Periodic maintenance is essential for top Power Unit performance. Use Table 3-2 as a guide for normal periodic maintenance. In hot and dusty environments some maintenance procedures should be performed more frequently, as indicated by the footnotes in the table.

Maintenance, replacement or repair of emission control devices and systems may be performed by

any engine repair establishment or individual. However, warranty work must be completed by an authorized Cummins/Onan dealer.

**⚠WARNING** *Accidental or remote starting can cause severe personal injury or death. Disconnect both of the Power Unit's remote control connectors (10-Pin and 4-Pin) and negative (-) battery cable at the Power Unit to prevent unintended starting while servicing the Power Unit.*

**TABLE 3-2. PERIODIC MAINTENANCE SCHEDULE**

| MAINTENANCE TASK   | FREQUENCY          |           |             |               |               |               |                | Page |
|--|--------------------|-----------|-------------|---------------|---------------|---------------|----------------|------|
|  | After First 50 Hrs | Every Day | Every Month | Every 150 Hrs | Every 500 Hrs | Every 800 Hrs | Every 1000 Hrs |      |
| General Inspection   |                    | •         |             |               |               |               |                | 3-8  |
| Check Engine Oil Level                                       |                    | •         |             |               |               |               |                | 3-9  |
| Check Engine Coolant Level                                   |                    | •         |             |               |               |               |                | 3-14 |
| Check Batteries <sup>1</sup>                                 |                    |           | •           |               |               |               |                | 6-1  |
| Change Engine Oil & Oil Filter <sup>1, 2, 3</sup>            | •                  |           |             | •             |               |               |                | 3-10 |
| Clean Spark Arrestor <sup>3</sup>                            |                    |           |             | •             |               |               |                | 3-12 |
| Replace Engine Air Filter <sup>2, 3</sup>                    |                    |           |             |               | •             |               |                | 3-11 |
| Replace Fuel Filter <sup>3</sup>                             |                    |           |             |               | •             |               |                | 3-13 |
| Check Coolant Anti-Freeze Protection                         |                    |           |             |               | •             |               |                | 3-14 |
| Valve Lash Adjustment <sup>6</sup>                           |                    |           |             |               |               | •             |                | -    |
| Flush Engine & Inverter/Charger Coolant Systems <sup>4</sup> |                    |           |             |               |               |               | •              | 3-14 |
| Replace Coolant Pressure Cap <sup>4</sup>                    |                    |           |             |               |               |               | •              | 3-14 |
| Replace Engine V-Belt <sup>6</sup>                           |                    |           |             |               |               |               | •              | -    |

1. Perform more often when operating in hot weather.  
 2. Perform more often when operating in dusty conditions.  
 3. Perform at least once a year.  
 4. Perform at least once every two years.  
 5. Perform every 75 hours when using high sulfur fuel. See RECOMMENDED ENGINE OIL (Page 3-5).  
 6. Must be performed by trained and experienced personnel (authorized Cummins/Onan service representatives).

## GENERAL INSPECTIONS

Inspect the Power Unit before the first start of the day and after every eight hours of Generator Mode operation.

### Oil Level

Check engine oil level (Figure 3-4).

### Engine and Inverter/Charger Cooling Systems

**⚠ CAUTION** *Operating the Power Unit when coolant level is low can cause serious engine damage.*

**Coolant:** Check the level of coolant in the coolant reservoir and look for leaks around the bottom of the Power Unit and the Inverter/Charger and on the ground below. Minor leaks that can be replenished by daily additions of coolant to the reservoir should be repaired by a qualified service technician as soon as possible. Larger leaks are cause for shutting down the Hybrid Power System until it can be repaired.

**Ground Clearance:** To prevent overheating and to reduce fouling with dust and debris, make sure the normal ground clearance under the Power Unit is not being reduced by sloping ground, curbs, logs or other objects. Repark the coach if necessary and/or remove any objects blocking the air inlet or air outlet.

### Exhaust System

**⚠ WARNING** *EXHAUST GAS IS DEADLY! Do not operate the Power Unit if there is an exhaust leak or any danger of exhaust gases entering or being drawn into the coach.*

Look and listen for exhaust system leaks while the Power Unit is running. Shut down the Power Unit if a leak is found and have it repaired before operating the Power Unit again.

Look for openings or holes between the Power Unit compartment and coach interior if the engine sounds louder than usual. Have all such openings or holes closed off or sealed to prevent exhaust gases from entering the coach.

Replace dented, bent or severely rusted sections of the tailpipe and make sure the tailpipe extends at least 1 inch (25.4 mm) beyond the perimeter of the coach.

**⚠ WARNING** *Do not park the coach in high grass or brush. Contact with the exhaust system can cause a fire.*

Park the coach so that the Power Unit exhaust gases can disperse away from the coach. Barriers such as walls, snow banks, high grass and brush and other coaches can cause exhaust gases to accumulate in and around the coach.

Do not operate power ventilators or exhaust fans while the coach is standing with the Power Unit running. The ventilator or fan can draw exhaust gases into the coach.

### Fuel System

Check for leaks at hose, tube and pipe fittings in the fuel supply system while the Power Unit is running and while it is stopped. Check flexible fuel hose sections for cuts, cracks, and abrasions. Make sure the fuel line is not rubbing against other parts. Replace worn or damaged fuel line parts before leaks occur.

**⚠ WARNING** *Diesel fuel leaks can lead to fire. Do not operate the Power Unit if operation causes fuel to leak.*

Prime the fuel system if the Power Unit ran out of fuel.

### Batteries

Check the battery terminals for clean, tight connections. Loose or corroded connections have high electrical resistance. See *Section 6. Coach Batteries*.

### Mechanical

Look for mechanical damage and listen for unusual noises. Check the Power Unit mounting bolts.

To prevent overheating and to reduce fouling with dust and debris, make sure the Power Unit's normal ground clearance is not being reduced by sloping ground, curbs, logs or other objects. Repark the coach if necessary and/or remove any objects blocking the air inlet or air outlet.

## CHECKING ENGINE OIL LEVEL

**⚠ WARNING** *State and federal agencies have determined that contact with used engine oil can cause cancer or reproductive toxicity. Avoid skin contact and breathing of vapors. Use rubber gloves and wash exposed skin.*

1. Park the coach on level ground, shut down the Power Unit and remove the front access door.
2. Unscrew the oil fill cap, pull out the dip stick and wipe it clean. Reinsert the dip stick and secure

the cap. Remove the cap and dipstick again to check the oil level (Figure 3-4).

3. Add or drain oil as necessary. See RECOMMENDED ENGINE OIL (p. 3-5). Keep the oil level between the FULL and ADD marks.

**⚠ CAUTION** *Too much oil can cause high oil consumption. Too little oil can cause severe engine damage. Keep the oil level between the FULL and ADD marks.*

4. Reinsert the dipstick and secure the oil fill cap.

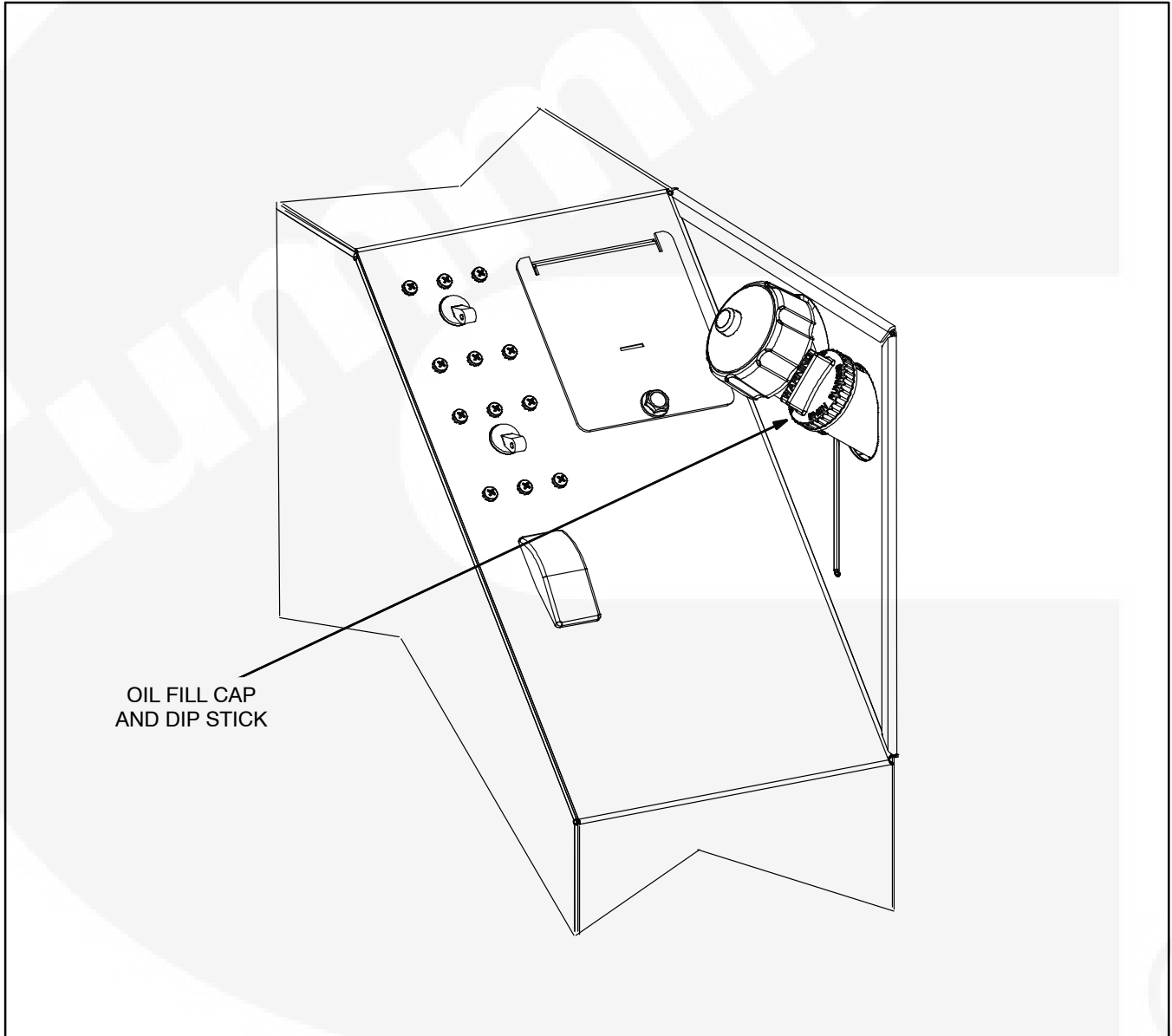

FIGURE 3-4. CHECKING ENGINE OIL LEVEL

## CHANGING ENGINE OIL AND OIL FILTER

**⚠WARNING** State and federal agencies have determined that contact with used engine oil can cause cancer or reproductive toxicity. Avoid skin contact and breathing of vapors. Use rubber gloves and wash exposed skin.

**Accidental or remote starting can cause severe personal injury or death. Disconnect both of the Power Unit's remote control connectors (10-Pin and 4-Pin) and negative (-) battery cable at the Power Unit to prevent unintended starting while servicing the Power Unit.**

Refer to Table 3-2 for scheduled engine oil changes and to the control panel for the oil filter part number. Change oil more often in hot and dusty environments.

1. Place a pan under the oil drain plug (Figure 3-5), run the Power Unit until warm and shut it off.

2. Unscrew the oil fill cap, remove the oil drain plug and drain all the oil from the engine. **Reinstall the oil drain plug securely.**

3. Loosen two bottom access cover screws and rotate the cover out of the way.

4. Spin off the oil filter canister and clean the filter mounting surface on the engine block. Remove the old gasket if it remains.

5. Make sure the gasket is in place on the new filter and apply a thin film of clean oil to the gasket. Spin the new filter on until the gasket just touches the block. Turn it an additional 1/2 to 3/4 turn. Do not overtighten.

6. Refill with 4 quarts (3.8 liters) of oil and check oil level.

**⚠CAUTION** Too much oil can cause high oil consumption. Too little oil can cause severe engine damage. Keep the oil level between the FULL and ADD marks.

7. Close the filter access opening.

8. Dispose of the used oil and oil filter according to local environmental regulations.

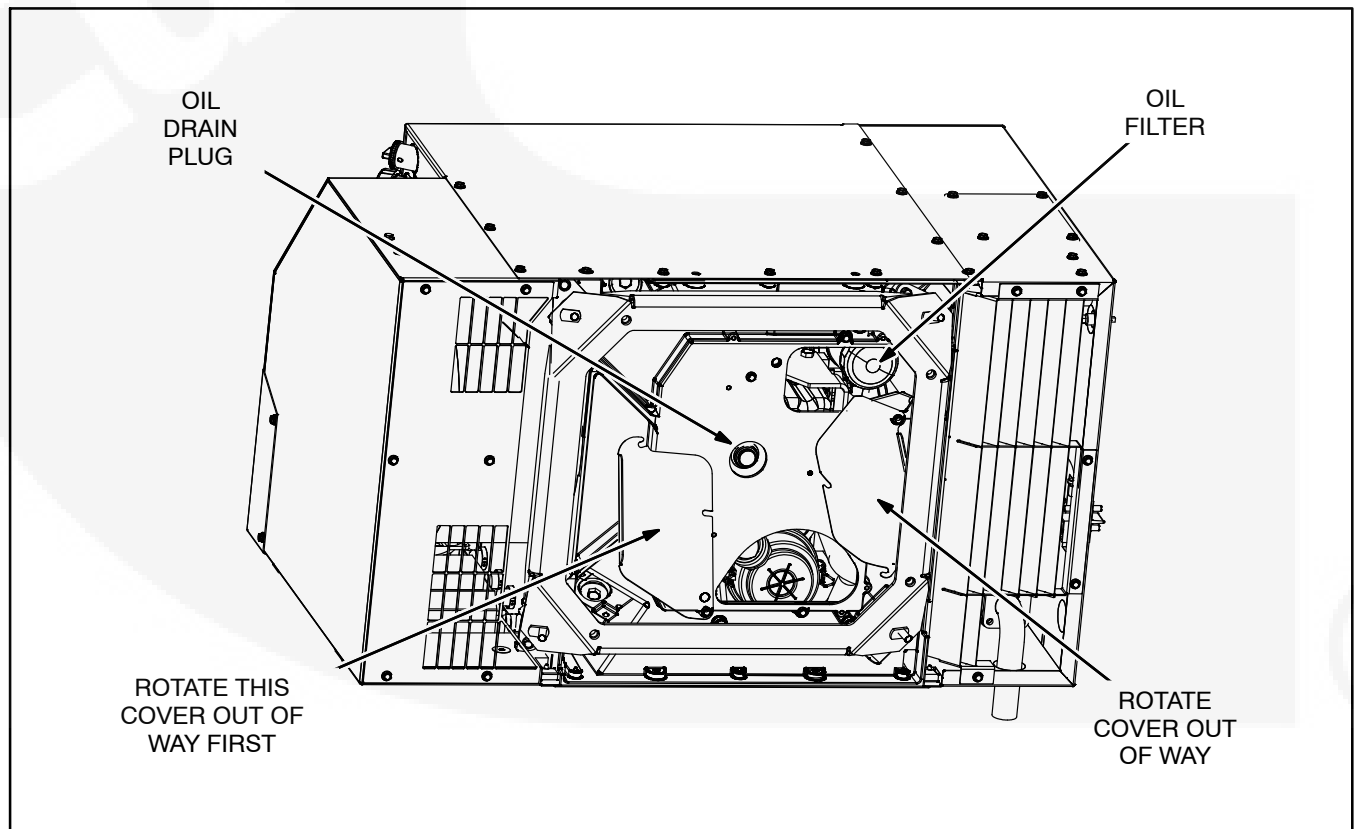

FIGURE 3-5. OIL DRAIN PLUG AND FILTER ACCESS FROM BOTTOM OF POWER UNIT

## REPLACING THE AIR FILTER ELEMENT

Refer to Table 3-2 for scheduled air filter replacements and to the control panel for the air filter part number. Replace it more often in dusty environments.

Loosen two bottom access cover screws and rotate the cover out of the way (Figure 3-6). Remove the air filter housing end cap (two spring clips) and replace the filter element.

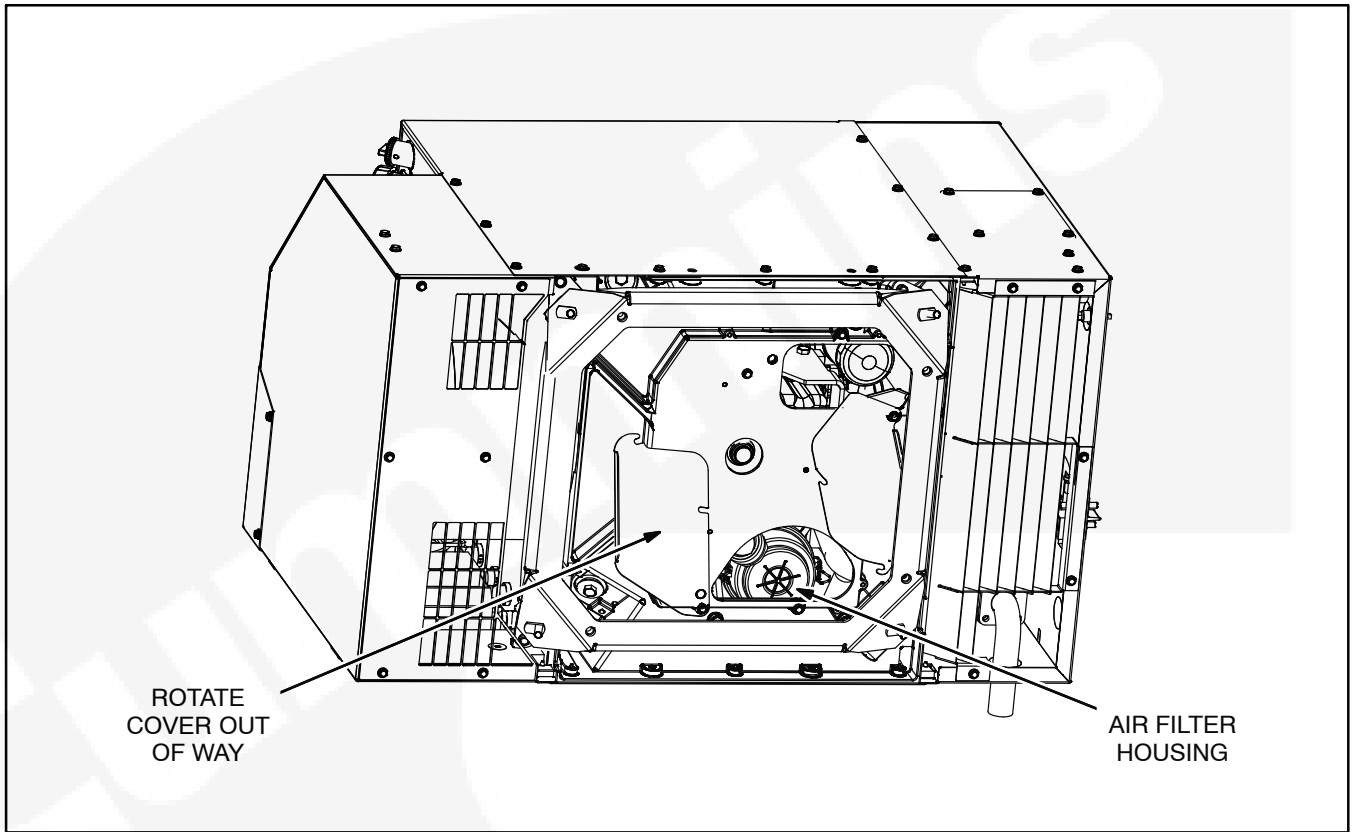

FIGURE 3-6. REPLACING THE AIR FILTER ELEMENT



## CLEANING THE SPARK ARRESTOR

Refer to Table 3-2 for scheduled cleaning of the spark arrestor muffler (which meets U.S. Forest Service requirements). Cleaning is required for maximum Power Unit performance.

**⚠WARNING** *A hot muffler can cause severe burns. Let the muffler cool down before removing or installing the cleanout plug.*

The muffler is mounted inside the Power Unit housing (Figure 3-7). The spark arrestor cleanout plug is

located on the bottom of the muffler and is accessible by removing the louvers on the air outlet opening in the bottom of the Power Unit (5 screws) or side access cover. Clean out the spark arrestor muffler as follows:

1. Remove the cleanout plug from the muffler.
2. Restart the Power Unit and load it nearly to full power. Let the Power Unit run for about five minutes to expel the soot in the muffler.
3. Stop the Power Unit, allow the muffler to cool down and then reinstall the plug.

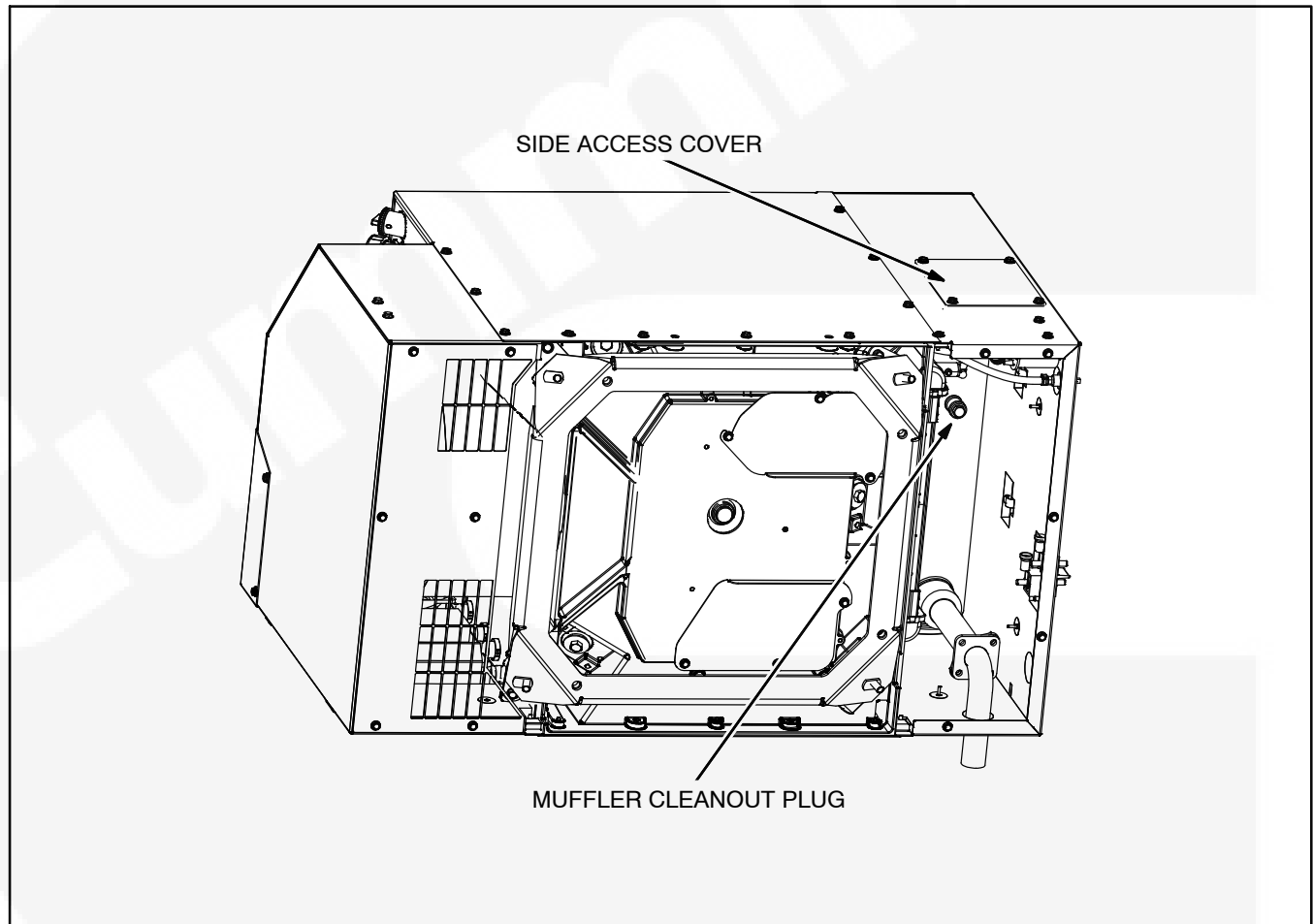

FIGURE 3-7. SPARK ARRESTOR CLEANOUT PLUG ACCESS FROM BOTTOM OF POWER UNIT

## REPLACING THE FUEL FILTER

See Table 3-2 for scheduled fuel filter replacements and to the control panel for the fuel filter part number. A dirty fuel filter may be the cause of a failure to start.

**⚠WARNING** *Diesel fuel is combustible and can cause severe personal injury or death. Do not smoke near diesel fuel tanks or equipment. Keep flames, sparks, pilot lights, electrical switches, arc-producing equipment and all other sources of ignition well away. Keep a type ABC fire extinguisher in the coach.*

*Close any fuel line shutoff valve before disconnecting the fuel line from the filter.*

*Accidental or remote starting can cause severe personal injury or death. Disconnect both of the Power Unit's remote control connectors (10-Pin and 4-Pin) and negative (-) battery cable at the Power Unit to prevent unintended starting while servicing the Power Unit.*

**⚠CAUTION** *Wipe dirt off the ends of the fuel hoses connected to the in-line filter to keep dirt out of the fuel system when replacing the filter.*

Loosen two bottom access cover screws and rotate the cover out of the way. (Figure 3-8). Use a paper towel or rag to clean the ends of the hoses connected to the filter and to catch any fuel that spills.

Loosen the coolant hose clamp in front of the filter. Then remove the filter clamp screw and pull the filter out. Disconnect the fuel hoses from the old filter and connect them to the new filter, using the new hose clamps in the filter kit. Use side cutters to cut the old hose clamps if they are not worm-screw clamps. Secure the new filter in place with its clamp and screw and retighten the coolant hose clamp.

Close the access door and prime the fuel system for at least 1 minute to displace the air in the new filter and fill it with fuel.

Dispose of the fuel filter and paper towel or rag according to local regulations.

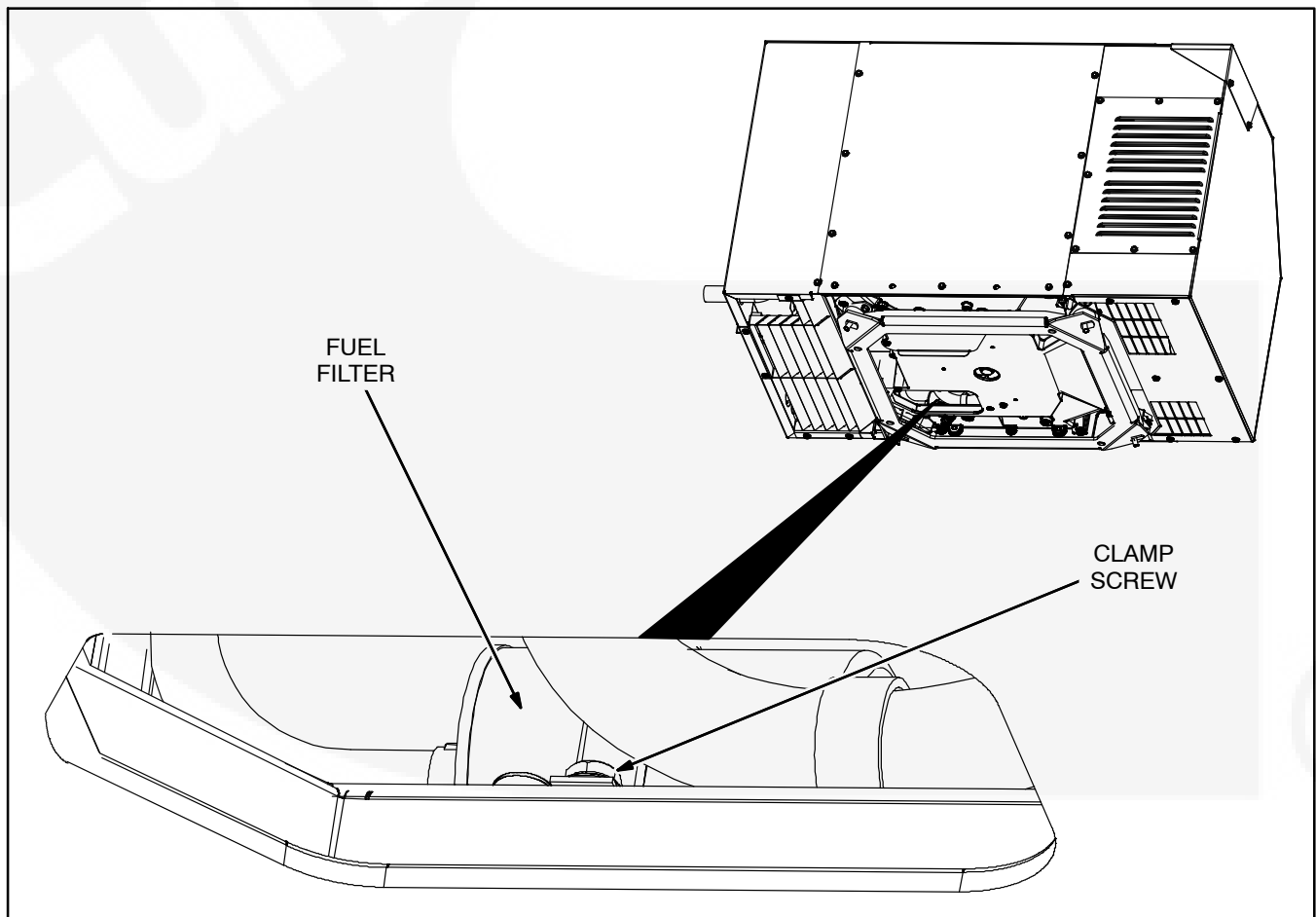

FIGURE 3-8. FUEL FILTER ACCESS FROM BOTTOM OF POWER UNIT

## MAINTAINING ENGINE AND INVERTER/CHARGER COOLING SYSTEMS

Refer to Table 3-2 for scheduled maintenance. The engine cooling system is filled with a 50/50 mixture of ethylene glycol anti-freeze and water when the Power Unit leaves the factory, which is suitable for temperatures down to -34° F (-37° C).

### Recommended Coolant

See RECOMMENDED COOLANT (p. 3-4). This applies to engine and Inverter/Charger cooling systems.

### Pressure Cap

Replace the pressure cap (Figure 3-9) every two years (seals deteriorate and leak). Proper cooling system pressure (16 psi) is essential for optimal engine cooling and minimal coolant loss.

### Draining and Cleaning Engine Cooling System

**⚠WARNING** *Hot coolant spray can cause severe burns. Let the engine cool before releasing the pressure cap or removing the drain cap.*

***Accidental or remote starting can cause severe personal injury or death. Disconnect both of the Power Unit's remote control connectors (10-Pin and 4-Pin) and negative (-) battery cable at the Power Unit to prevent unintended starting while servicing the Power Unit.***

Let the engine cool before removing the pressure cap, which is stowed behind the access cover on the control panel. Relieve any remaining pressure by turning the pressure cap slowly, without pushing down. When the pressure has been relieved, push down on the cap, turn it the rest of the way and withdraw it. Then open the radiator and engine block drain valves (Figure 3-9) and drain the coolant into suitable containers.

**⚠WARNING** *Ethylene glycol antifreeze is considered toxic. Dispose of it according to local regulations for hazardous substances.*

Flush and clean the cooling system before refilling. Radiator cleaning chemicals are available at local auto parts stores. Follow the instructions for cleaning and flushing that come with the cleaning solution.

### Refilling Engine Cooling System

Close the block and radiator drain valves.

Pull the hose connected to the pressure cap assembly out as far and as high as it will go. Remove the pressure cap and fill the system using a funnel inserted into the fill hose to prevent coolant from entering the vent hose and blocking the escape of air as the system fills. The system *will seem full when it actually is not* if the air cannot escape through the vent hose. If the vent hose does get blocked, pinch the overflow hose and blow the vent hose clear. Start and operate the genset for a few minutes while keeping the fill opening elevated to promote venting of air from the coolant. Shut down the genset and add coolant as necessary. Secure the pressure cap and fill the recovery tank to the COLD mark.

### Draining and Filling Inverter/Charger Cooling System

Drain the Inverter/Charger cooling system at the same time as the engine cooling system by disconnecting the hose at the lower fitting on the Power Unit. Then reconnect the hose and fill the system through the fill opening. Prime the coolant with the coolant pump for two minutes (p. 3-2). Refill as coolant level drops and air is purged from the cooling system.

**Note:** *If the Power Unit and Inverter/Charger are located at opposite ends of the coach it could take up to 2 gallons (8 liters) of coolant to fill the system because of the long length of the supply and return hoses between the Power Unit and Inverter/Charger.*

### Coolant Level Check

Check coolant level in the reservoir tank (Figure 3-9) before the first startup of each day and fill to the COLD mark if necessary.

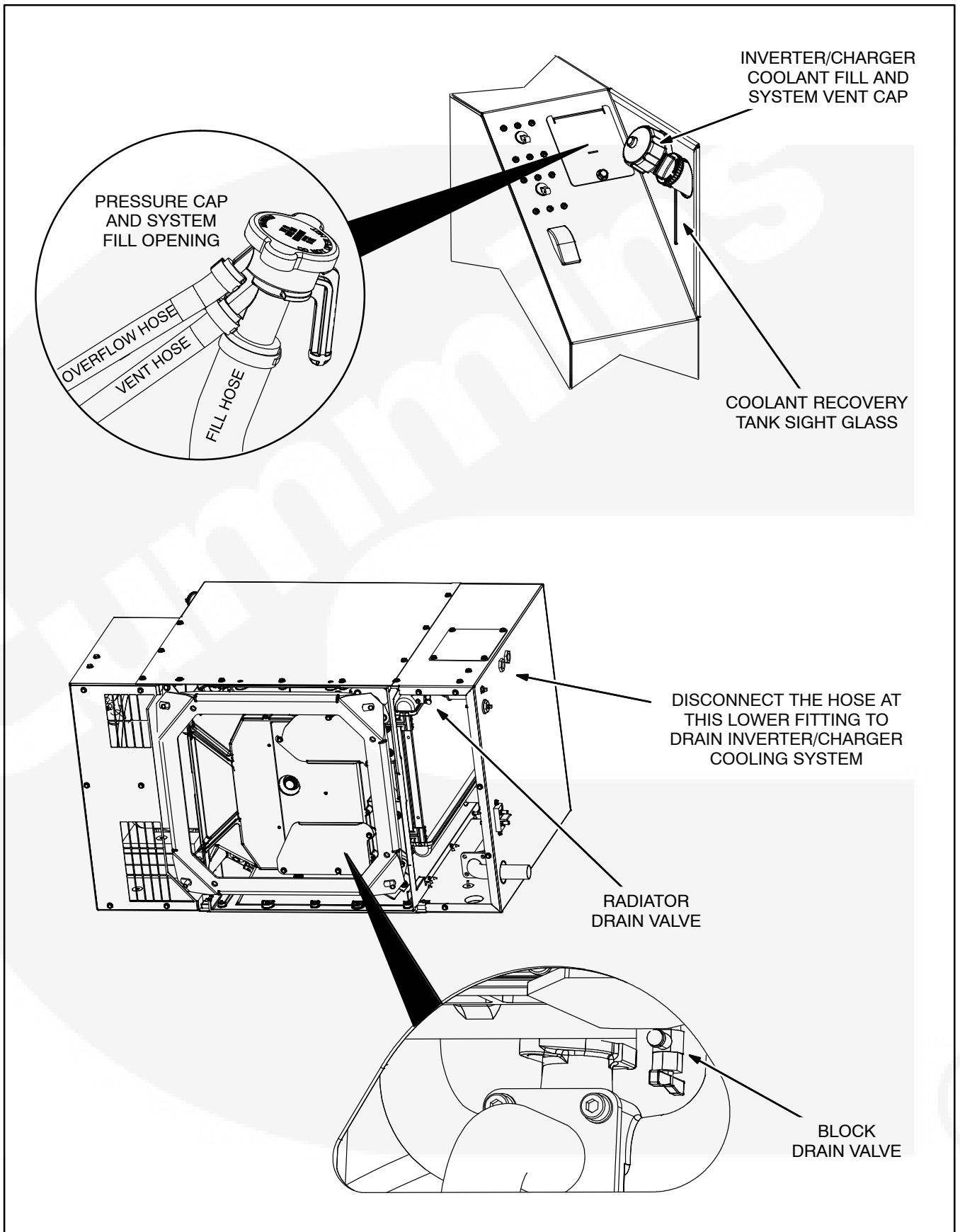

**FIGURE 3-9. FILLING AND DRAINING ENGINE AND INVERTER/CHARGER COOLING SYSTEMS**



**THIS PAGE LEFT INTENTIONALLY BLANK**

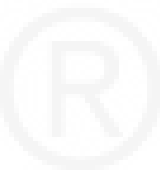

# 4. Inverter/Charger

## GENERAL

The Hybrid Power System's two Inverter/Chargers have three main functions. They work together to convert the Power Unit's two 3-phase, variable-voltage, variable-frequency power outputs into 60Hz, 120/240V AC power. They provide typical Inverter/Charger functions by converting AC power for battery charging and inverting battery DC power to AC for the coach circuits. They also optimize the use of Shore and Power Unit power flow to where it is most needed—AC circuits or battery charging.

When power demand exceeds the output of the Power Unit, such as when starting air conditioners, the Inverter/Chargers shed (reduce) battery charging to provide full AC power. If needed, the Inverter/Chargers can also draw battery power to further boost AC power. As AC demand decreases, boost is reduced and battery charging is restored.

When needed, battery charging is provided at up to 280 amps DC, with power factor correction (140 amps DC in Model 1215 HQDSB systems). Battery condition is maintained by accurate battery state of charge (SOC) monitoring based on battery temperature, current, and voltage.

The Inverter/Chargers have microprocessors that communicate with each other, with the Power Unit, Transfer Switch and Operator Panel, providing an integrated control and monitoring system with built-in system diagnostics.

See *Section E. Specifications* for Inverter/Charger ratings and specifications.

## MAINTENANCE

The electronics in the Inverter/Chargers are kept cool by internal fans and liquid-cooled cold plates

that are connected by hoses to a heat exchanger in the Power Unit. See *MAINTAINING ENGINE AND INVERTER/CHARGER COOLANT SYSTEMS* (p. 3-14) to check, prime, drain and fill the Inverter/Charger cooling system.

Cooling air must be allowed to circulate freely through the Inverter/Charger enclosure to avoid overheating the the Inverter/Chargers. Do not use the Inverter/Charger enclosure to stow enclosure to stow clothes, luggage, gear, oil or liquid or gaseous fuel containers.

**⚠ WARNING** *Do not store liquid or gaseous fuel containers in the same enclosures as the Inverter/Chargers, Transfer Switch, batteries or other spark-producing equipment.*

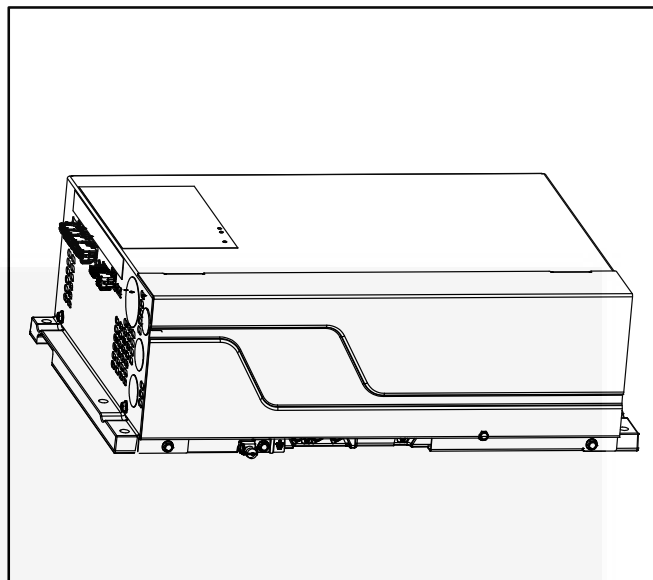
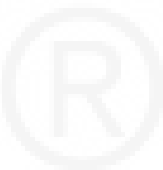

FIGURE 4-1. INVERTER/CHARGER



**THIS PAGE LEFT INTENTIONALLY BLANK**



# 5. Transfer Switch

## GENERAL

The Hybrid Power System's automatic Transfer Switch safely connects the most appropriate source of available power: Inverter/Charger or Shore Power. Power for AC circuits will be provided by the Power Unit through the Inverter/Charger when the Power Unit is available. Shore Power quality is continually monitored, and when the Power Unit is not available, such as during Quiet Time, and Shore Power quality is acceptable, the Transfer Switch will connect Shore Power to the Coach's AC distribution panel. Switching is done with minimal power interruption.

The Transfer Switch has a microprocessor that communicates with the Power Unit, Inverter/Charger and Operator Panel providing an integrated control and monitoring system with built-in system diagnostics.

See *Section E. Specifications* for Transfer Switch ratings and specifications.

## MAINTENANCE

Keep the space around the Transfer Switch open so that air can circulate freely. Do not use the Transfer Switch enclosure to stow clothes, luggage, gear, oil or liquid or gaseous fuel containers.

**⚠WARNING** *Do not store liquid or gaseous fuel containers in the same enclosures as the Inverter/Chargers, Transfer Switch, batteries or other spark-producing equipment.*

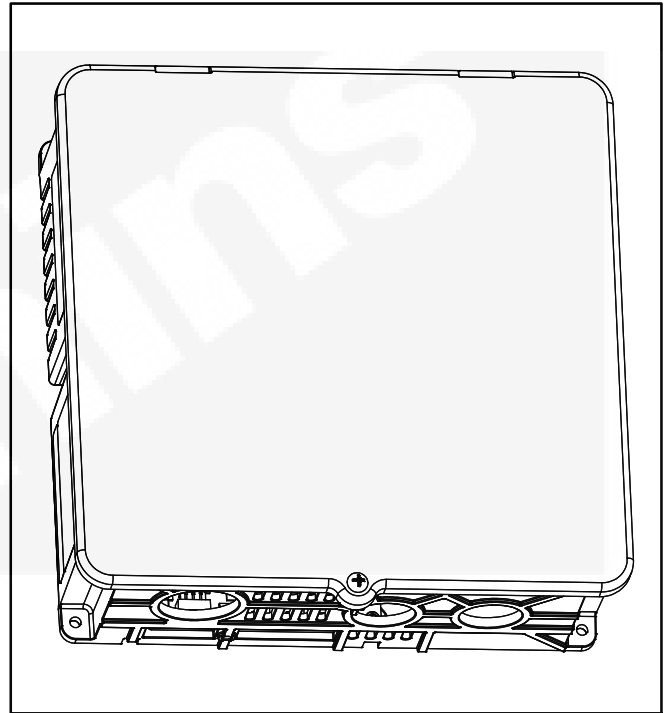

FIGURE 5-1. TRANSFER SWITCH





**THIS PAGE LEFT INTENTIONALLY BLANK**



# 6. Coach Batteries

---

## CHARGING THE COACH BATTERIES

The Hybrid Power System provides three-stage, temperature-compensating battery charging and keeps track of the State of Charge of the coach batteries by continuously measuring voltage and DC current to and from the batteries.

### Stage 1—High (Bulk) Charging

A constant charging current is maintained during Stage 1 Charging. Current is limited by the maximum charging current, other system loads and/or shore power breaker size (p. A-17).

Stage 1 Charging starts when Shore Power is connected or Generator Mode is turned on. Stage 1 Charging is maintained until reaching the high charge (bulk) voltage appropriate for the battery type set up for the Hybrid Power System. See BATTERY SETUP (p. A-21).

### Stage 2—Medium (Absorption) Charging

The Hybrid Power System advances to Stage 2 Charging when high charge (bulk) voltage is reached. High charge voltage is maintained until charging current drops to the absorption current level or absorption time expires.

### Stage 3—Low (Float) Charging

The Hybrid Power System advances to Stage 3 Charging when charging current drops to the absorption current level or when the absorption time expires. The Hybrid Power System will maintain the float charge voltage appropriate for the battery type set up for it when in either Shore Power or Generator Mode.

## MAINTAINING THE COACH BATTERIES

**⚠WARNING** *Battery acid can cause severe burns. Always wear safety glasses and protective clothing when working with batteries. If acid gets in your eyes or on your skin, flush with water for 15 minutes and get medical attention.*

*Remove hanging jewelry, rings and bracelets before working on batteries. They can short and weld to battery terminals causing severe burns.*

*Lead-Acid Batteries produce explosive hydrogen gas that can lead to severe personal injury—Do not smoke near batteries—Disconnect all loads and inputs and observe proper Battery Connect / Disconnect Sequences.*

*Secure DC terminal protective covers to prevent accidental shorting with metal tools.*

Carefully read and follow all of the battery manufacturer's recommendations for maintenance, storage and safety. Also note the following:

1. Discharging more than 80 percent of a battery's total capacity can reduce its life, as can leaving it discharged more than 50 percent for extended periods of time. For maximum battery life, do not discharge more than 40 percent of a battery's capacity. The Operator Panel displays the state of charge (p. A-2).
2. The electrolyte level in Wet Cell batteries should be checked at least once a month. Always keep the level just above the top of the plates in each battery cell by adding as much distilled water as necessary. Allowing the electrolyte level to fall below the top of the plates will lead to shorter battery life.
3. Equalizing is an important maintenance procedure for Wet Cell batteries, though not all Wet Cell batteries require equalizing. See EQUALIZING THE COACH BATTERIES (p. 6-2).

## EQUALIZING THE COACH BATTERIES

### Reasons for Equalizing

Equalizing is an important maintenance procedure for Wet Cell batteries, though not all Wet Cell batteries require equalizing. Do not equalize batteries unless the battery manufacturer's instructions call for equalizing as a maintenance procedure. Equalizing can only be performed when the Hybrid Power System is set up for *Wet Cell* batteries.

**⚠ WARNING** *Equalizing batteries not intended to be equalized will cause overheating and possible fire. Do not equalize batteries unless the battery manufacturer's instructions call for equalizing as a maintenance procedure.*

1. Batteries produce electricity as the electrolyte (sulfuric acid and water) chemically reacts with the lead plates to form lead sulfate. Charging with electricity reverses the process: the lead plates are restored and the sulfate ion is returned to the electrolyte. Normal charging does not, however, completely restore the lead plates. After many cycles lead sulfate can accumulate on the plates reducing the effective plate area, thus robbing battery capacity. Over time the lead sulfate will crystallize, further increasing battery resistance. Equalizing removes most of the accumulation of lead sulfate by controlled over-charging at a higher charging voltage for a specific length of time.
2. Because sulfuric acid is denser than water (higher specific gravity), stratification of water and acid takes place over time. The bubbling action involved in equalizing remixes the water and acid to restore the uniform specific gravity throughout the battery cell necessary for optimum battery performance.
3. Equalizing is also useful for determining whether a battery should be replaced. The higher the specific gravity, the higher the State of Charge (SOC). If specific gravity after equalizing is still

less than that specified by the battery manufacturer:

- A. The battery might be old, approaching the end of its life
  - B. The battery might have been left discharged for too long
  - C. Electrolyte might have been lost or spilled
  - D. A bad cell might be developing
  - E. Too much water might have been added to the electrolyte
4. Many battery experts recommend that wet cell batteries be equalized periodically, anywhere from once a month to once a year, depending on usage. Follow the battery manufacturer's recommendations.

### Equalizing Safety Precautions and Procedures

See Page A-22 for Equalizing safety precautions and procedures.

## STORING THE COACH BATTERIES

When preparing the coach for off-season storage make sure that the batteries are fully charged, that each cell in a wet-cell battery has the proper level of electrolyte and that the Coach DC Disconnect Switch is in its Disconnect position. It is not necessary, nor is it recommended, that the cables be disconnected from the coach batteries. The Hybrid Power System automatically enters battery saver mode (less than 1 milliamp current draw) to prevent draw-down of the batteries during storage.

**⚠ CAUTION** *Make sure the Coach DC Disconnect Switch is in its Disconnect position during storage, otherwise the Hybrid Power System will not enter battery saver mode and could draw down the batteries.*

Follow all storage recommendations provided by the battery manufacturer.

## REPLACING THE COACH BATTERIES

**⚠WARNING** *Do not use batteries of other types than specified for use with the Hybrid Power System. They can explode, causing severe personal injury.*

**⚠CAUTION** *Engine starting batteries are not suitable for deep-cycle service. They have thin plates designed for brief, high-current service, which warp and become unserviceable as a result of the heat generated in deep-cycle service.*

1. The Hybrid Power System is designed for use only with deep-cycle batteries of the Wet Cell, Gel Cell (GEL) or Absorbed Glass Mat (AGM) types. Other types of batteries can explode when subjected to the charging-inverting duty cycle of this application.
2. Do not mix different types of batteries (Wet Cell, GEL, AGM). Each type has a different set of optimal charging parameters. Performance will not be optimal if there is a mix of battery types: some will be overcharged, others undercharged. Overcharging reduces battery life.
3. Do not mix old and new batteries. The life of the new batteries will be reduced by overcharging to keep the old batteries charged.
4. The Hybrid Power System must be configured for the installed battery type and bank capacity. It must be reconfigured if the batteries are replaced with a different type or battery bank capacity is either increased or decreased. See BATTERY SETUP (p. A-21).
5. Make sure to properly reconnect the coach batteries. The batteries must be connected for an output of 12 Volts. Check voltage before connecting to the Inverter/Charger (p. 6-4). See *Appendix D. Battery Connections*.
6. Bolt the battery temperature sensor to a centrally located positive (+) terminal in the battery bank. The sensor provides feedback to the Inverter/Charger for temperature-compensated charging. See *Appendix D. Battery Connections*.
7. Used batteries must be disposed of in accordance with local environmental regulations.

## CONNECTING THE COACH BATTERY CABLES

Figure 6-1 illustrates how to connect *each* Inverter/Charger and the Power Unit to the batteries. Also see CONNECTING TWO INVERTER/CHARGERS in Appendix D for connecting *both* Inverter/Chargers to the batteries. The cables from the two Shunt/Fuse Blocks should be the only cables connected to the positive (+) terminals of the Coach Batteries.

### Connecting/Disconnecting Battery Cables

**⚠ CAUTION** *Damage to the Inverter/Charger as a result of reverse polarity is not covered under Warranty.*

Make sure battery polarity is correct.

To keep sparks from igniting explosive battery gases when connecting and disconnecting battery cables, disconnect Shore Power (to prevent charging), turn the Coach DC Disconnect Switch to its Disconnect position (to disconnect DC loads and power down the Hybrid Power System) and observe the proper Battery Connect-Disconnect Sequences.

**⚠ WARNING** *Battery acid can cause severe burns. Always wear safety glasses and protective clothing when working with batteries. If acid gets in your eyes or on your skin, flush with water for 15 minutes and get medical attention.*

*Remove hanging jewelry, rings and bracelets before working on batteries. They can short and weld to battery terminals causing severe burns.*

*Lead-Acid Batteries produce explosive hydrogen gas that can lead to severe personal injury—Do not smoke near batteries—Disconnect all loads and inputs and observe proper Battery Connect / Disconnect Sequences.*

*Secure DC terminal protective covers to prevent accidental shorting with metal tools.*

## Inverter/Charger Connect Sequence

The high capacitance of the Inverter/Charger can cause sparking whenever battery cables are connected or disconnected. This is normal, do not be alarmed. To reduce sparking at the batteries while connecting the cables:

1. Connect the positive (+) cable(s) at the Batteries and then at the Inverter/Charger(s).
2. Connect the negative (-) cable(s) at the Batteries and then at the Inverter/Charger(s).

## Inverter/Charger Disconnect Sequence

To reduce sparking at the batteries while disconnecting the cables:

1. Disconnect the negative (-) cable(s) from the Inverter/Charger(s) and then from the Batteries.
2. Disconnect the positive (+) cable(s) from the Inverter/Charger(s) and then from the Batteries.

## Cable Terminal Torques

Torque all battery cable terminal in accordance with Table 6-1. Use a lock washer and nut on each terminal.

TABLE 6-1. THREADED-STUD TERMINAL TORQUE

| Terminals        | Torque                         |
|------------------|--------------------------------|
| Shunt/Fuse Block | 19 ft-lbs (26 N-m)             |
| Inverter/Charger | 12 ft-lbs (16 N-m)             |
| Power Unit       | 7.5 ft-lbs (10 N-m)            |
| Battery          | Manufacturer's Recommendations |

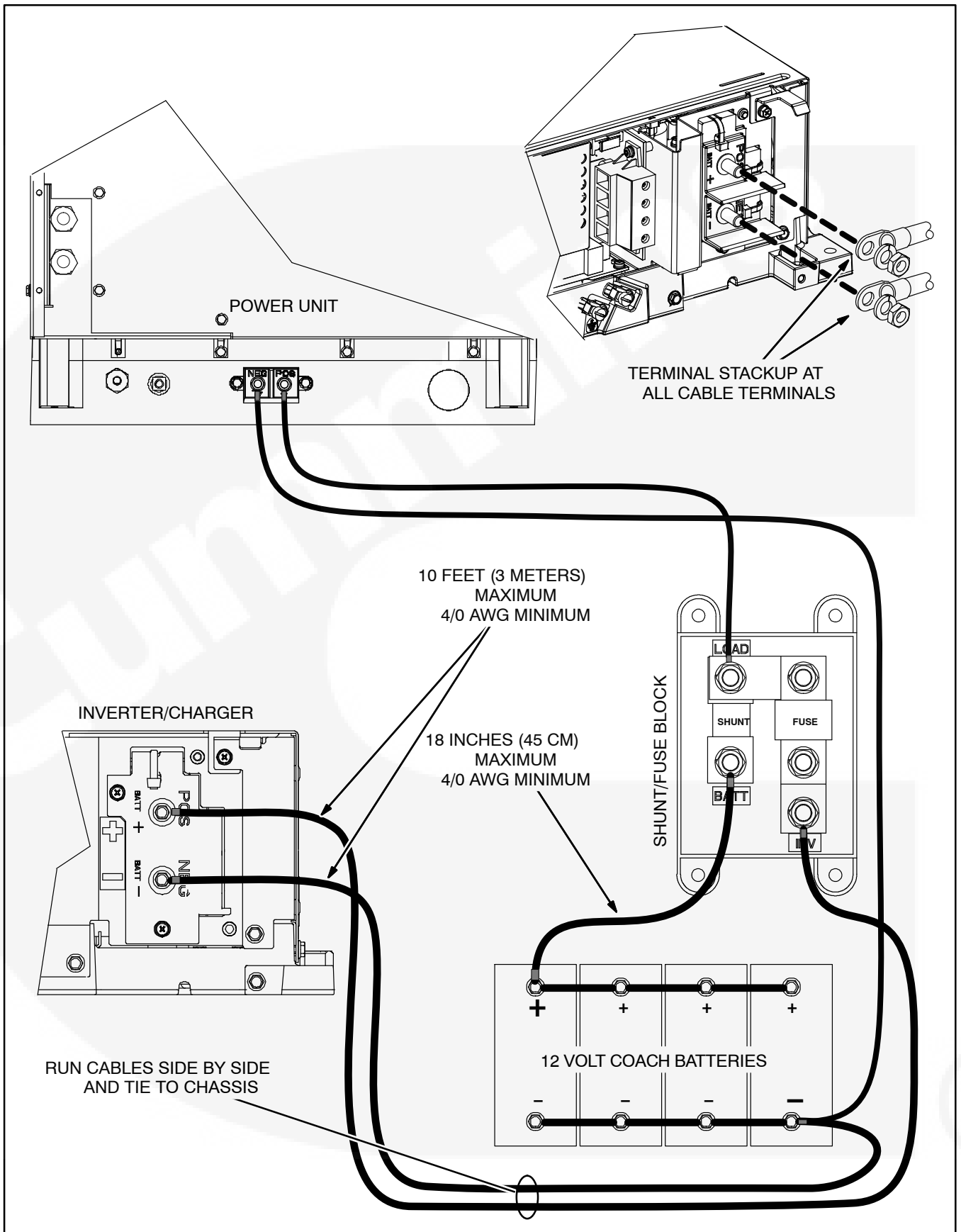

FIGURE 6-1. TYPICAL COACH BATTERY CABLE CONNECTIONS

## REPLACING A COACH BATTERY FUSE

### Location

The two Shunt/Fuse blocks (Figure 6-2) are mounted near the positive (+) terminals of the Coach Batteries, one for each Inverter/Charger.

### Shunt

The two shunts, one for each Inverter/Charger, are used by the Hybrid Power System to continuously track current to and from the coach batteries to determine the State of Charge. The shunt leads are connected to the Inverter/Charger. Each lead is protected by a 2 amp, blade-type automotive fuse.

### Coach Battery Fuse

The 400 amp Class T fuse in each Shunt/Fuse Block protects the connected Inverter/Charger if the cables are misconnected.

### Replacing Battery Fuse

1. Disconnect Shore Power (to stop charging) and turn the Coach DC Disconnect Switch to its Disconnect position (to disconnect DC loads and to power down the Hybrid Power System).

2. Disconnect the Inverter/Charger (Figure 6-1) from the Coach Batteries observing the proper Battery Disconnect Sequence (p. 6-4).
3. Remove the battery fuse cover from the fuse block (Figure 6-2).
4. Loosen the two battery fuse terminal nuts and remove the old fuse. Do not loosen the three other terminal nuts on the fuse block.
5. Install the replacement fuse and torque the terminals to 19 ft-lbs (26 N-m). Use a lock washer and nut on each terminal.
6. Secure the fuse cover.
7. Reconnect the Inverter/Charger to the Coach Batteries observing the proper Battery Connect Sequence (p. 6-4). Torque all battery cable terminals in accordance with Table 6-1.
8. Turn the Coach DC Disconnect Switch to its Connect position to wake up the Hybrid Power System.



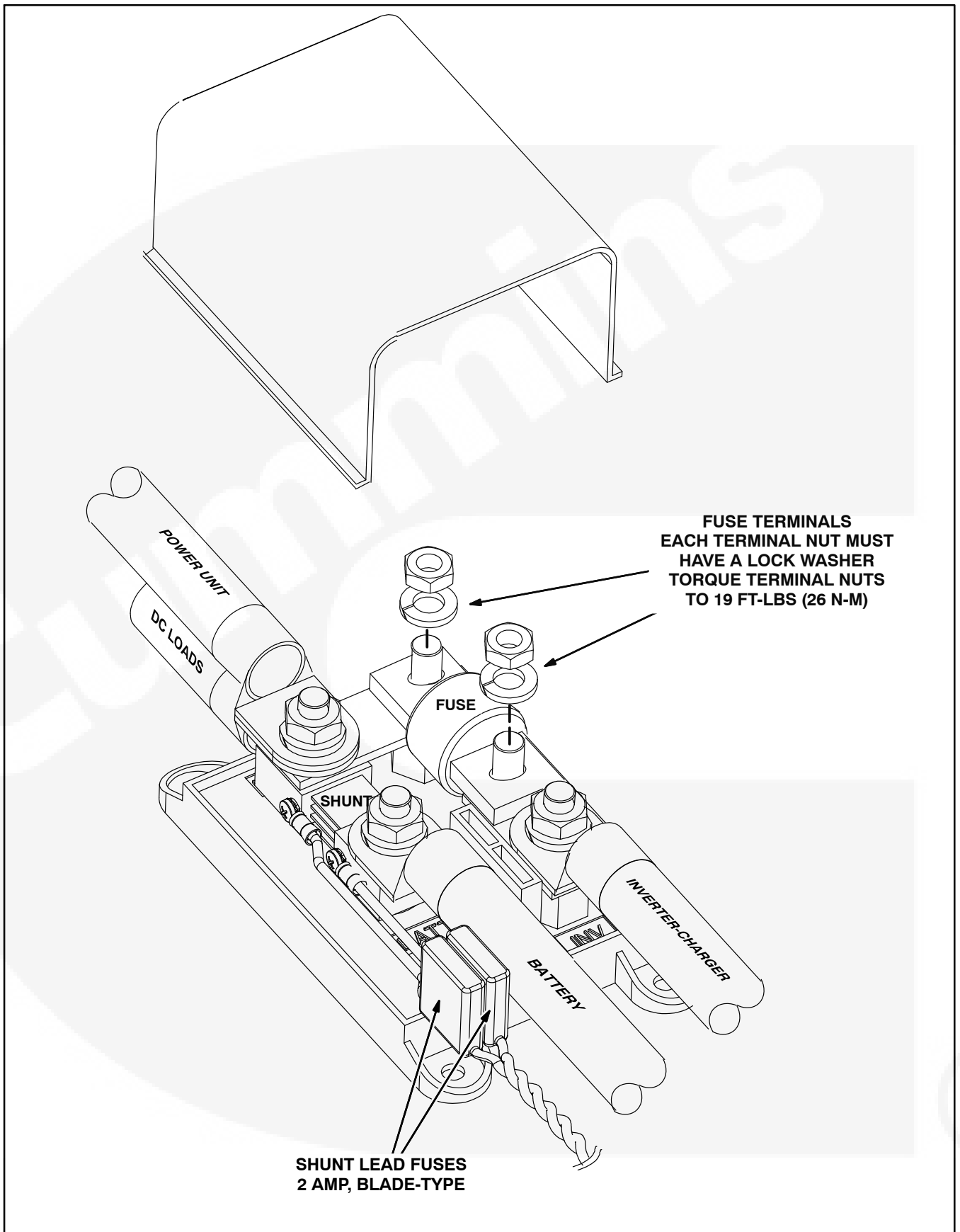
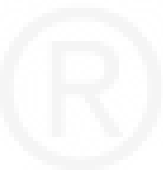

**FIGURE 6-2. REPLACING BATTERY FUSE**





**THIS PAGE LEFT INTENTIONALLY BLANK**



# Appendix A. Operator Panel

## ABOUT THE OPERATOR PANEL

Use the Operator Panel (Figure A-1) to control and monitor the Hybrid Power System. The panel has eight function buttons, a digital display screen and six status lights.

### Function Buttons

Press **Auto** to confirm and enable AUTO operation (p. A-3).

Press **Manual** for manual control of Inverter Mode and/or Generator Mode (p. A-7).

Press **Menu** to go to the Menu screens (p. A-8).

Press **Clock** to reset the current time (p. A-6).

Press the **Up** or **Down** arrow button to select items on a menu screen or increment the values.

Press **Back** to return to the previous screen.

Press **OK** to accept the selected value or enable the action.

### Display Screen

Press any function button to turn on the display screen. See Page A-18 to adjust screen brightness, contrast and duration.

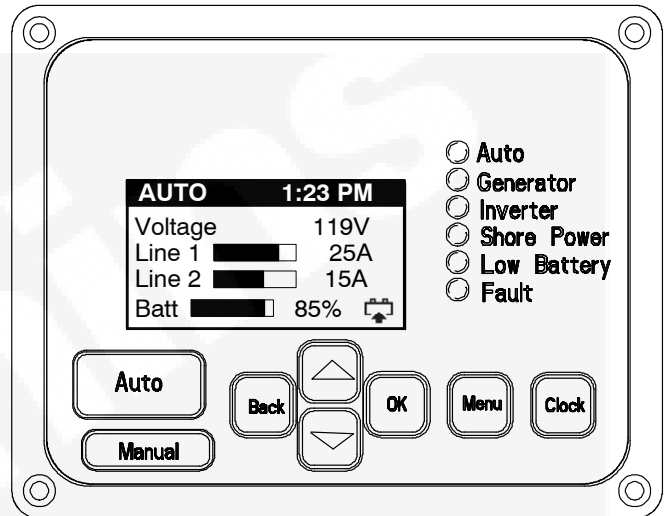

FIGURE A-1. OPERATOR PANEL

### Status Lights

TABLE A-1. STATUS LIGHTS

| LED Name    | Color  | Status Indicated   |
|-------------|--------|--|
| Auto        | Green  | AUTO is enabled to supply power in Generator, Inverter or Shore Power Mode |
| Generator   | Green  | Power is being supplied in Generator Mode.                                 |
| Inverter    | Green  | Power is being supplied in Inverter Mode.                                  |
| Shore Power | Green  | Power is being supplied in Shore Power Mode.                               |
| Low Battery | Yellow | Coach Battery Charge is getting low.                                       |
| Fault       | Red    | A Hybrid Power System fault has occurred.                                  |

## HOME SCREEN

Press **Menu** one or more times to go to the Home Screen (Figure A-2). The Home Screen displays:

- Whether the Hybrid Power System is in Auto, Auto when Quiet Time (QT) is in effect, or Manual
- The current time
- The AC Voltage and Amperage in each line (Line 1, Line 2) (The bar graphs illustrate how much of the available current is being used in each line.)
- The percentage of useable battery charge remaining, also illustrated by the bar graph
- Whether the batteries are being charged or discharged, as illustrated by the battery icon with an up arrow (charging) or down arrow (discharging)

**Note: The Status Light indicates which Mode is providing power: Generator Mode, Inverter Mode or Shore Power Mode.**

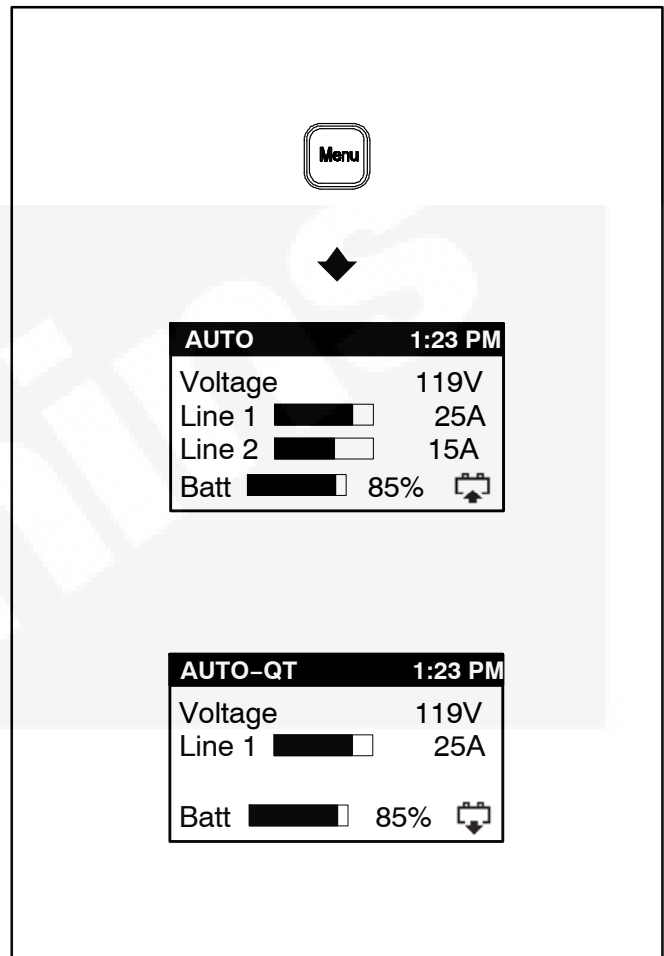

FIGURE A-2. TYPICAL HOME SCREENS

## AUTO BUTTON

**⚠WARNING** **ENGINE EXHAUST IS DEADLY.** Engine exhaust gases include **CARBON MONOXIDE (CO)**, an odorless, colorless, poisonous gas that can cause severe personal injury or death. Symptoms of CO poisoning include:

- **Dizziness, Headache or Throbbing Temples**
- **Weakness or Muscular Twitching**
- **Sleepiness or Confusion**
- **Nausea or Vomiting**

**IF YOU OR ANYONE ELSE EXPERIENCES ANY OF THESE SYMPTOMS, GET OUT INTO FRESH AIR IMMEDIATELY. Get advice from 911, poison control or a medical center. Do not enable AUTO or start Generator Mode until the exhaust system has been repaired. Exhaust system installation must be in accordance with the Hybrid Power System Installation Manual.**

**Do not enable AUTO or start Generator Mode be-**

**fore going to sleep unless the coach has working CO detectors.**

**Do not enable AUTO or start Generator Mode unless the coach is out in fresh, open air.**

**Disable AUTO and stop Generator Mode when parking the coach in a garage or other confined space.**

**⚠WARNING** **Disable AUTO and stop Generator Mode before fueling the coach to prevent ignition of flammable vapors.**

The Hybrid Power System is intended for AUTO operation in daily use. It should be noted that AUTO is disabled each time you park or move the coach. This gives YOU the opportunity to confirm that AUTO operation is safe under the conditions.

**Note: See Page A-27 if either of these two prompts appear: “Auto Mode Expires in (5, 4, 3, 2, or 1) days” or “Safety Input Expired.”**

## To Enable AUTO

Confirm that it is safe to operate in Generator Mode and press **Auto**. Note the Quiet Times displayed on the CONFIRM AUTO screen (Figure A-3).

If the Quiet Times are okay, press **OK** to enable AUTO.

If the Quiet Times need be reset, see Page A-5 to reset the Quiet Times before enabling AUTO.

## AUTO Operation

When AUTO is enabled, the Auto and Inverter lights come on and you will have power available right away for most coach appliances, lights and power outlets.

From time to time the Inverter light will go out and the Generator light will come on, indicating that AUTO has switched to Generator Mode to recharge the coach batteries when charge drops to the preset START State of Charge (p. A-16) or to power the air conditioners when AUTO receives a power demand signal.

You should hear the Power Unit engine crank, start and run when AUTO switches to Generator Mode. AUTO will make up to three attempts to start the engine, allowing 60 second rest periods.

AUTO switches back to Inverter Mode 15 minutes after the air conditioner demand signal has stopped, unless it is recharging the batteries.

If Quiet Time has been enabled, AUTO will switch to Generator Mode as far ahead of time as necessary (could be several hours) to fully charge the batteries for the upcoming Quiet Time.

If AUTO is enabled while Generator Mode is under manual control, AUTO will turn off Generator Mode in 15 minutes unless the coach batteries are being charged or the air conditioners are running.

If Generator Mode is on and you do not want to disrupt operation when turning the ignition key or releasing the brake to move the coach, first exit AUTO. To do this, press **Manual**, select EXIT AUTO MODE (Figure A-7) and press **OK**. Generator Mode will stay on while driving until manually turned OFF.

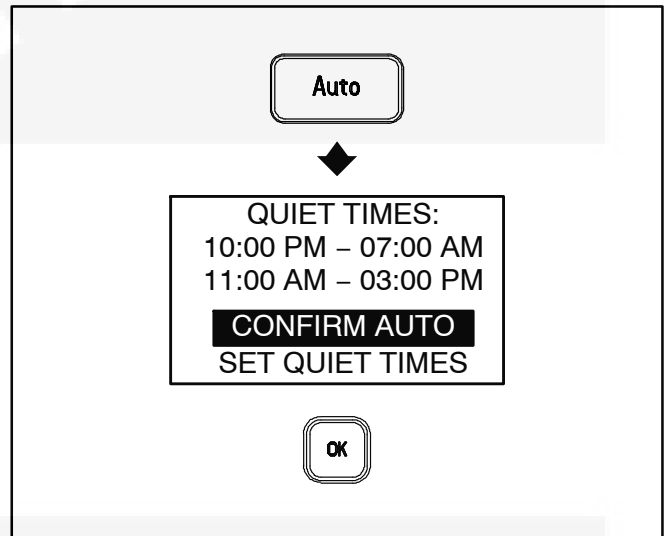

FIGURE A-3. ENABLE AUTO—QUIET TIMES OKAY

## To Set Quiet Times Before Enabling AUTO

**Note:** Reset Current Time (p. A-6) if the time zone has changed, otherwise the Quiet Times will occur an hour earlier or later than expected.

Two QUIET TIME periods can be set for each 24 hour period. The Quiet Time 1 default time period is 10:00 PM to 7:00 AM. Quiet Time 2 does not have a default time period.

Press **OK** with SET QUIET TIME selected.

Press **Up** or **Down** to select QUIET TIME 1.

Press **OK**.

Press **Up** or **Down** to toggle between ENABLE and DISABLE.

Press **OK** to accept ENABLE or DISABLE.

Press **Up** or **Down** to increment the Start and End times. Hold down the button for fast scroll. The time increment is 15 minutes.

Repeat the procedure for QUIET TIME 2.

Press **OK** to accept the settings and go back to the QUIET TIME screen.

Press **Up** or **Down** to select DONE.

Press **OK** to go back to CONFIRM AUTO screen.

Press **OK** to enable AUTO.

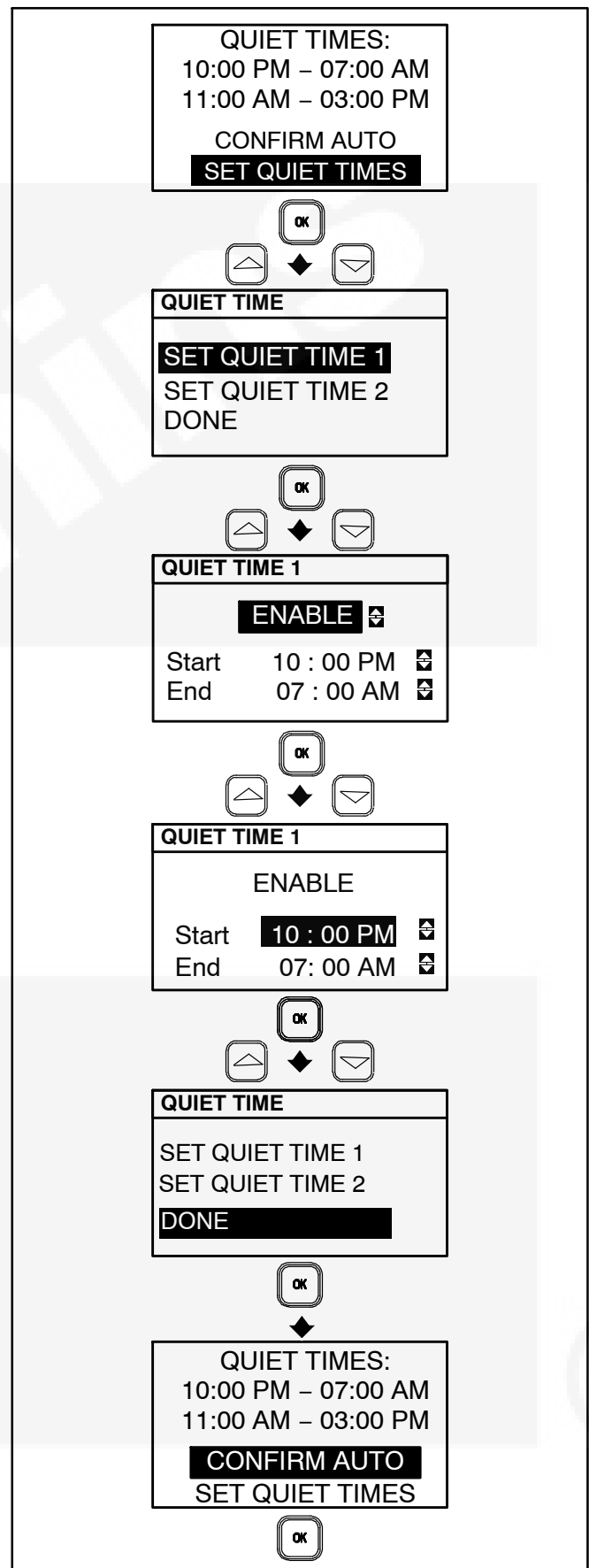

FIGURE A-4. ENABLE AUTO—RESET QUIET TIMES

## CLOCK BUTTON

### Set Current Time

Press **Clock**.

Press **Up** or **Down** to select SET CURRENT TIME.

Press **OK**.

Press **Up** or **Down** to increment the hour, minute and AM/PM. Hold down the button for fast scroll.

Press **OK** one or more times to accept the setting and go back to the home screen.

### Set Quiet Times

If the Hybrid Power System is in AUTO, use the Clock button and select SET QUIET TIMES to get to the Quiet Time screen (p. A-5).

On the Quiet Time screen select DONE to accept the Quiet Time settings and press the OK button.

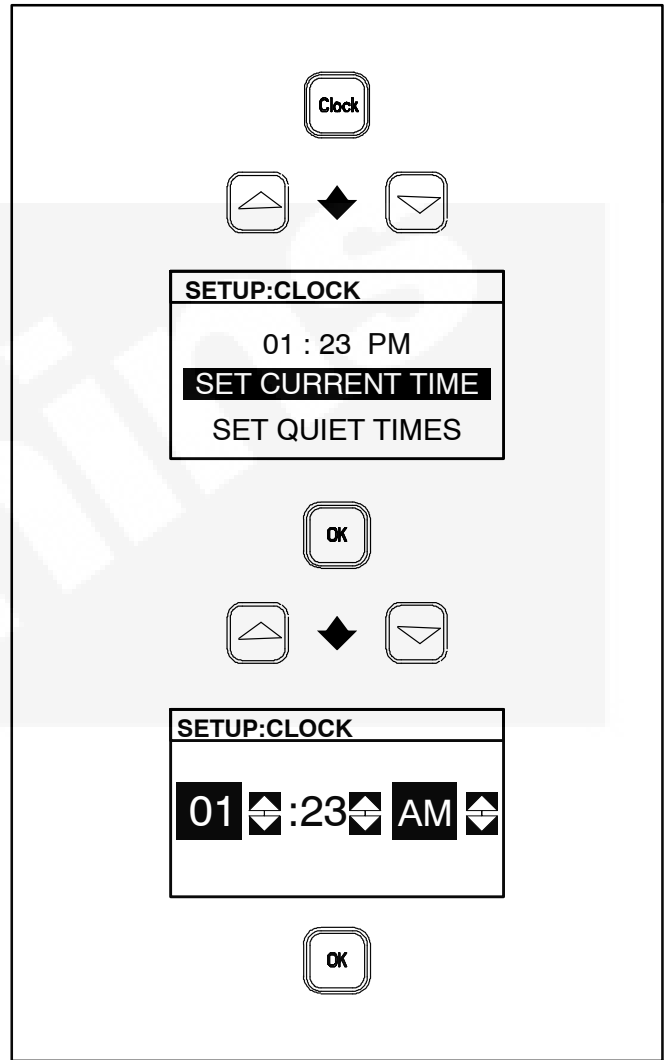

FIGURE A-5. CURRENT TIME SETUP



## MANUAL BUTTON

Press **Manual**.

Press **Up** or **Down** to select the desired action.

Press **OK** to enable the action.

### TURN ALL ON/OFF

TURN ALL ON if you want Inverter Mode to come on when you turn off Generator Mode.

TURN ALL OFF when it is necessary to save battery charge or fuel or perform maintenance.

### TURN INVERTER ON/OFF

TURN INVERTER ON when neither Generator Mode nor Shore Power Mode is available.

TURN INVERTER OFF when it is necessary to save battery charge or perform maintenance.

### TURN GENSET ON/OFF

Confirm that it is safe to operate in Generator Mode and TURN GENSET ON for manual control of Generator Mode. You will not hear or see any indication of the starting process for up to 15 seconds while the engine glow plugs pre-heat the combustion chambers.

The Generator light will come on after the Power Unit has warmed up for 30 seconds and you will have power available for to all coach appliances, lights, power outlets and air conditioners.

TURN GENSET OFF to stop Generator Mode and disable AUTO.

### EXIT AUTO MODE

EXIT AUTO MODE if the Hybrid Power System is in Generator Mode and you do not want to disrupt operation when turning the ignition key or releasing the brake to move the coach. Generator Mode will stay on while driving until manually turned off.

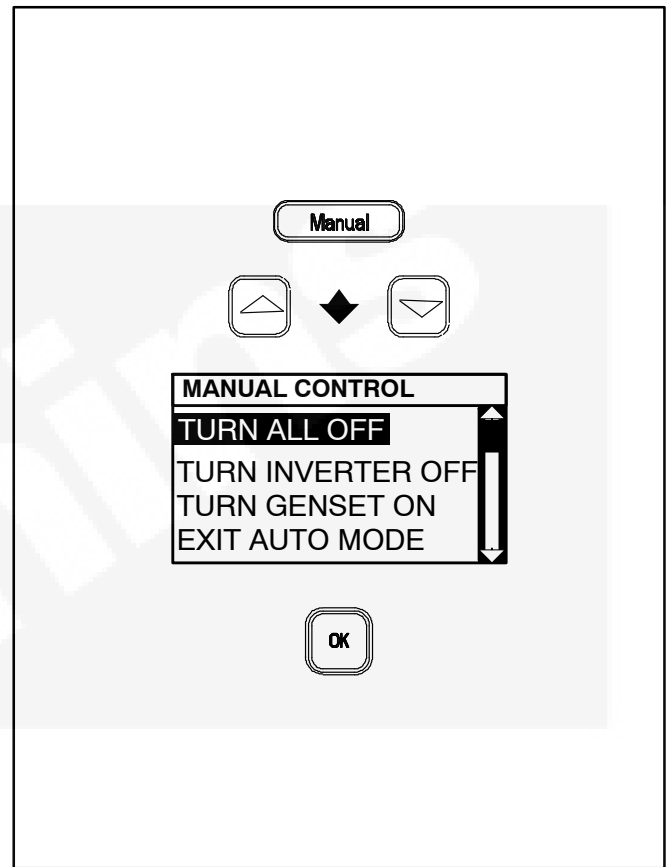

FIGURE A-6. MANUAL CONTROL SCREEN



## STATUS MENU

Press **Menu** to enter the top level Menu. There are three menu levels:

- Status – Top level Menu
- Setup – Last Item in the Status Menu (p. A-15)
- Service – Last Item in the Setup Menu (p. A-19)

Press **Up** or **Down** to select one of the following from the Status Menu:

- BATT STATUS
- AUTO STATUS
- GEN STATUS
- INV STATUS
- SHORE STATUS
- FAULT INFO
- SETUP (SUB-MENU)

Press **OK** to accept the selection.

Press **Menu** one or more times to go back to the home screen.

See the following pages for details about each menu item.

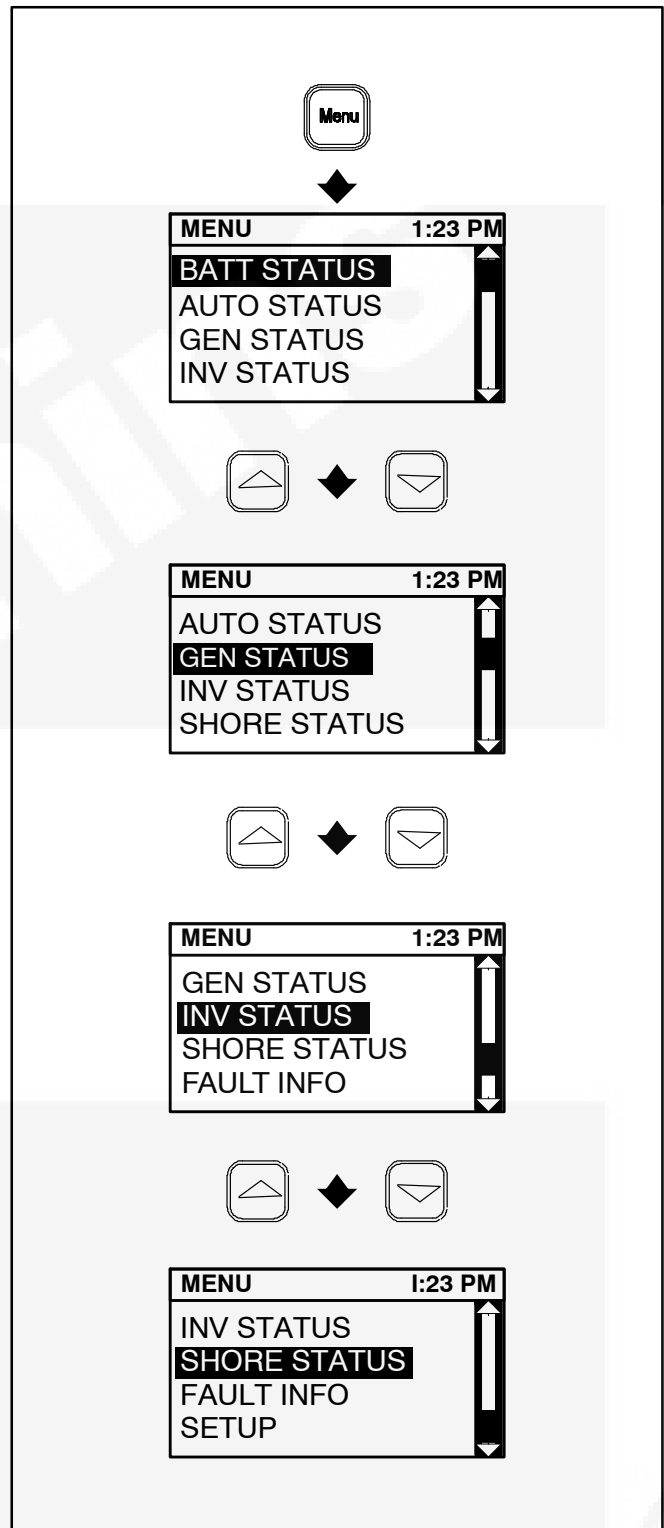

FIGURE A-7. STATUS MENU ITEMS

## BATT STATUS

Press **Menu**.

Press **Up** or **Down** to select BATT STATUS.

Press **OK**. The BATTERY(DC) screen displays the following information:

- Battery voltage
- If the batteries are being charged, the DC current (amperage) they are “Charging At”
- If the batteries are being discharged, the DC current (amperage) they are “Discharging At”
- The percentage of useable battery charge remaining, as also illustrated by the bar graph.
- “Life Available” in hours if discharging, or “Charge Time” if charging

Battery Life Available indicates the number of hours remaining at current power usage in Inverter Mode. Life available is recalculated every 4 minutes on the basis of the average usage over that period. The battery State of Charge is calculated on the basis of the continuously tracked current to and from the Coach Batteries and on various other factors such as battery type, battery bank capacity and battery temperature.

**Note: A full charge cycle is required after batteries have been reconnected to get an accurate Life Available indication.**

Press **Menu** one or more times to go back to the home screen.

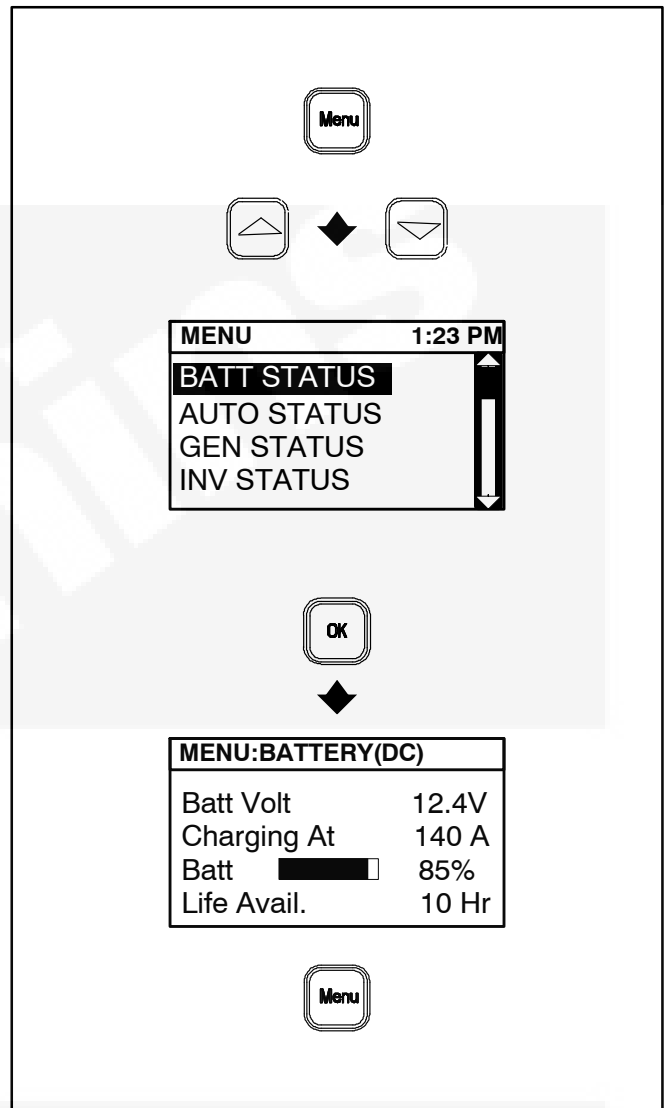

FIGURE A-8. BATTERY STATUS

## AUTO STATUS

The purpose of this status screen is to let you know why AUTO is or is not in Generator Mode.

Press **Menu**.

Press **Up** or **Down** to select AUTO STATUS.

Press **OK**. The AUTO screen will display one of the following as Auto Status:

- Standby – There is no load demand or need for Generator Mode to charge the batteries.
- Quiet Time – Quiet Time is in effect. Generator Mode will not respond to load demand or low batteries.
- Disabled – Auto was disabled manually or by the safety signal when the coach was parked or moved.
- Low Battery – Generator Mode is on to re-charge low batteries.
- Battery Overload – Generator Mode came on during Inverting Mode due to battery overload.
- Load Demand – Generator Mode is responding to a load demand.

**Note: AUTO switches from Generator Mode back to Inverter Mode 15 minutes after the air conditioner demand signal has stopped, unless it is recharging the batteries. This reduces the number of Power Unit starts and stops when there are cycling load demands, such as for air conditioning.**

The “Days Left” field indicates the number of days left before the AUTO safety signal must be cycled. See Page A-27.

Press **Menu** one or more times to go back to the home screen.

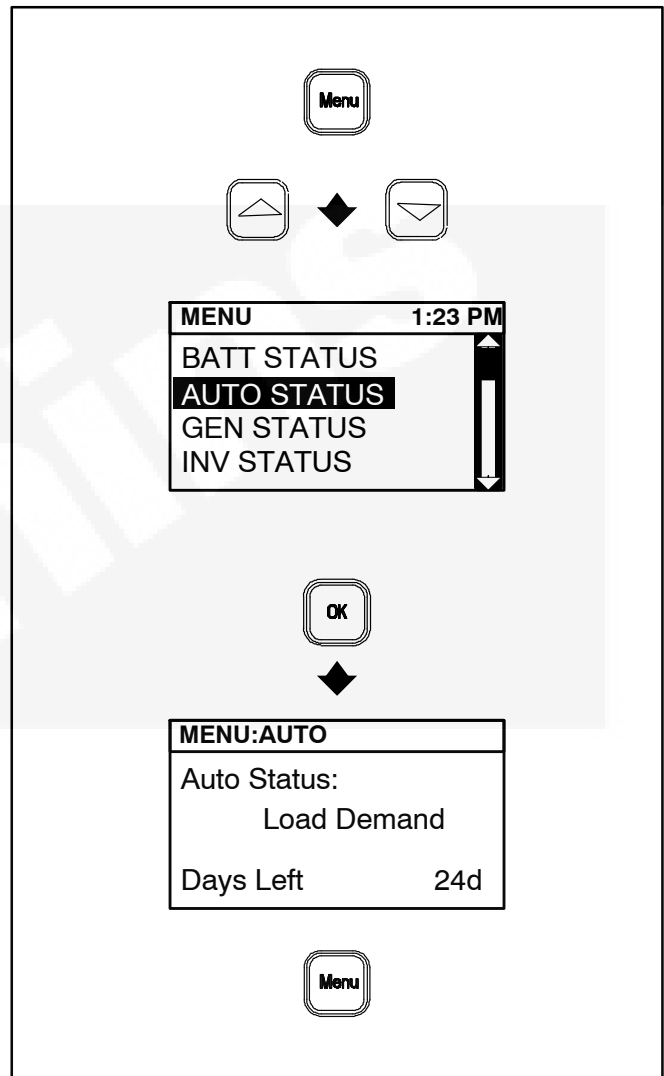

FIGURE A-9. AUTO STATUS

## GEN STATUS

Press **Menu**.

Press **Up** or **Down** to select GEN STATUS.

Press **OK**. The GENSET screen displays the following information:

- Engine RPM (load dependent, ranging from 1400 to 2600 RPM)
- Engine coolant temperature
- Hours (total running time)
- Line 1 Voltage and Amperage (AC)
- Line 2 Voltage and Amperage (AC)

Press **Menu** one or more times to go back to the home screen.

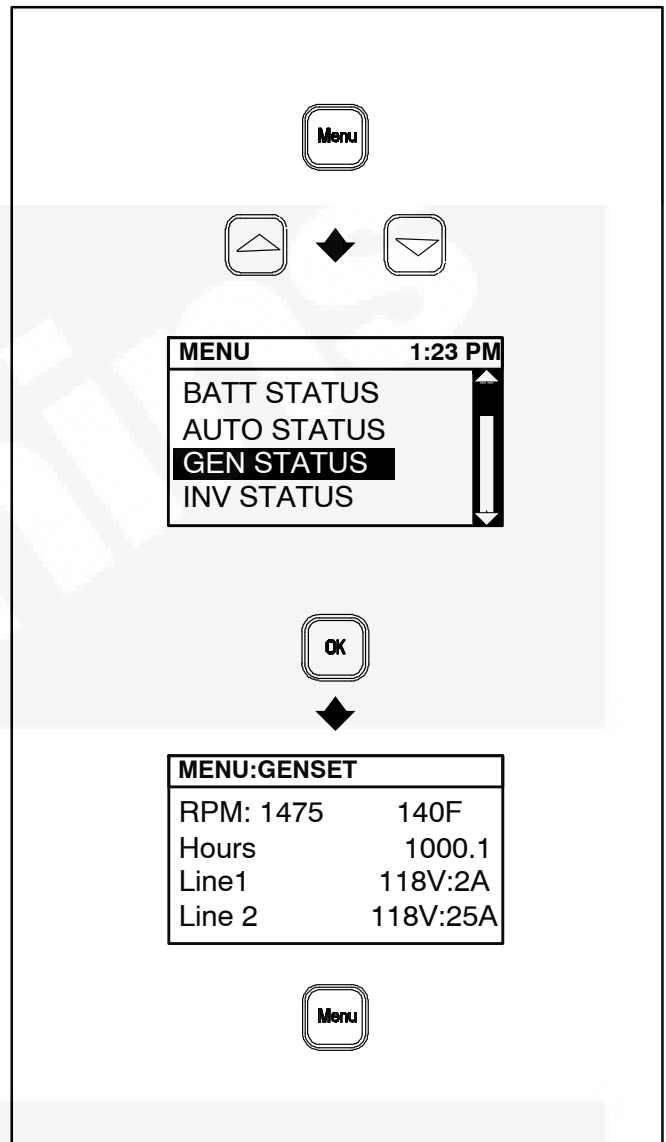

FIGURE A-10. GENSET STATUS

## INV STATUS

Press **Menu**.

Press **Up** or **Down** to select INV STATUS.

Press **OK**.

The INVERTER screen indicates whether or not Inverter Mode has been turned on. See Page A-7. If Inverter is “ON,” Inverter Mode will resume operation when shore power is disconnected or Generator Mode is turned off. Disable Inverter Mode if you do not want it to resume operation.

During Inverter Mode this screen also shows the voltage and amperage of the two Inverter/Charger outputs to the two AC sub-distribution panels.

**Note: The Secondary Inverter/Charger (HQDVB) used in Model 1215 Hybrid Power Systems does not provide inverting in Inverter Mode. The “Inverter 2” field will indicate “Off.”**

Press **Menu** one or more times to go back to the home screen.

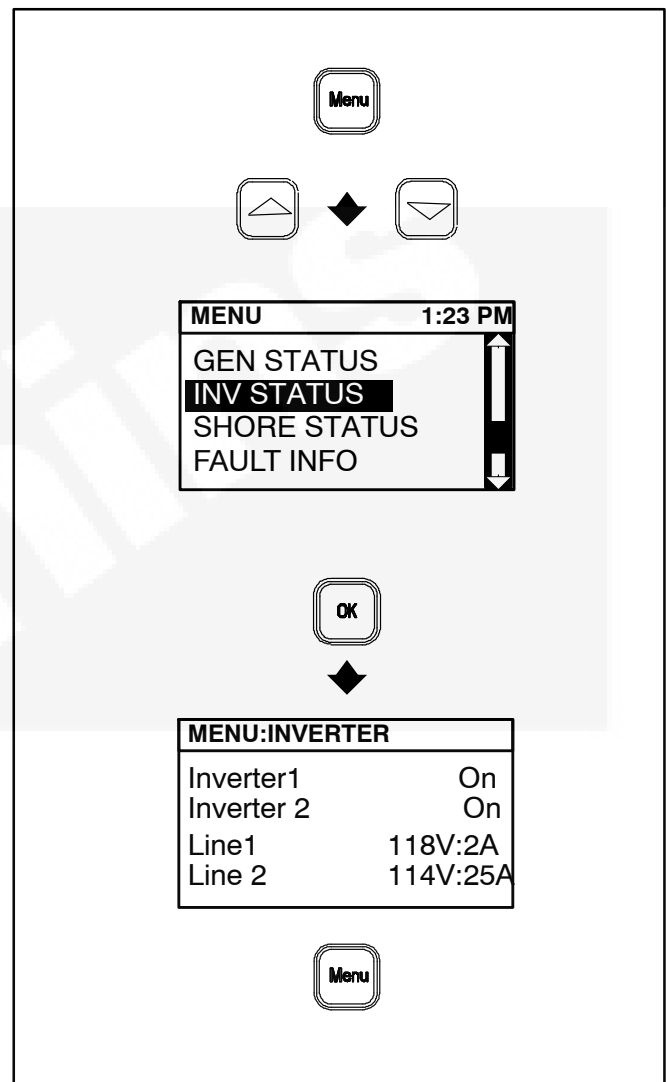

FIGURE A-11. INVERTER STATUS

## SHORE STATUS

Press **Menu**.

Press **Up** or **Down** to select SHORE STATUS.

Press **OK**. The SHORE screen displays one of the following in the “Shore Quality” field:

- Good
- Not Detected
- Over Frequency
- Under Frequency
- Reverse Polarity
- High Voltage
- Low Voltage
- Loss of Neutral
- Loss of L1
- Loss of L2

See *Appendix E. Specifications* regarding acceptable shore power.

This screen also shows the voltage and amperage in each shore supply line (Line 1, Line 2).

Press **Menu** one or more times to go back to the home screen.

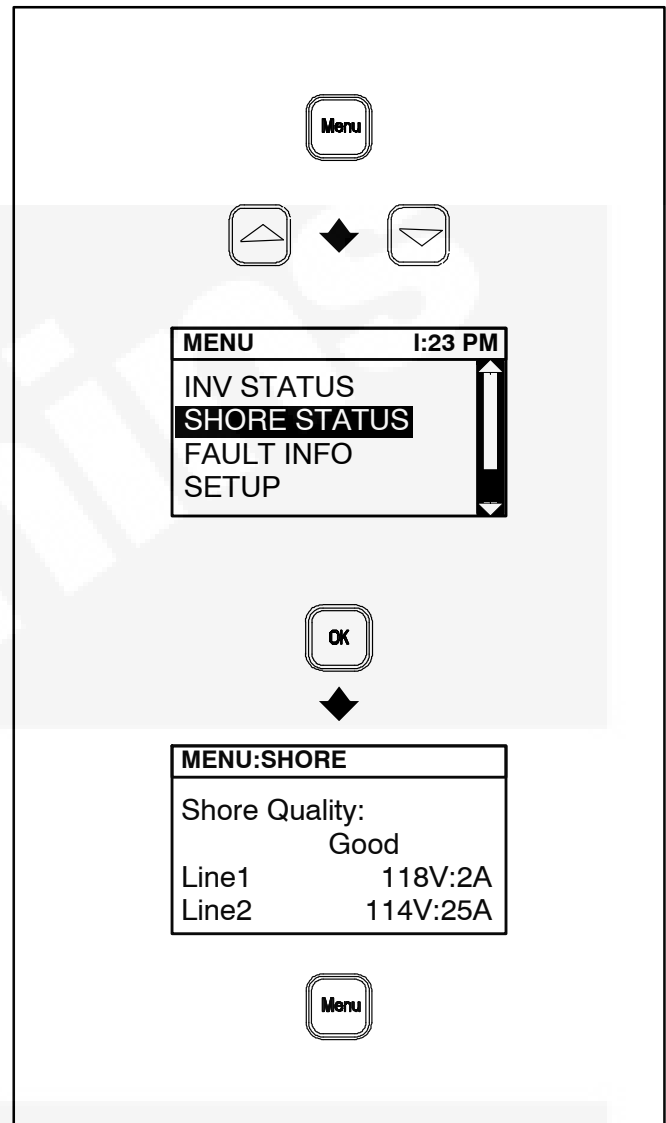

FIGURE A-12. SHORE STATUS

## FAULT INFORMATION

Press **Menu**.

Press **Up** or **Down** to select FAULT INFO.

Press **OK**. The FAULT screen displays the following information on up to 15 of the most recent faults:

- The Fault Code Number
- A brief description of the fault
- The accumulated time in hours that the Hybrid Power System had been powered up when the fault occurred.

See *Appendix C. Troubleshooting Fault Codes*.

Press **Up** or **Down** to scroll through the list of faults.

Press **Menu** one or more times to go back to the home screen.

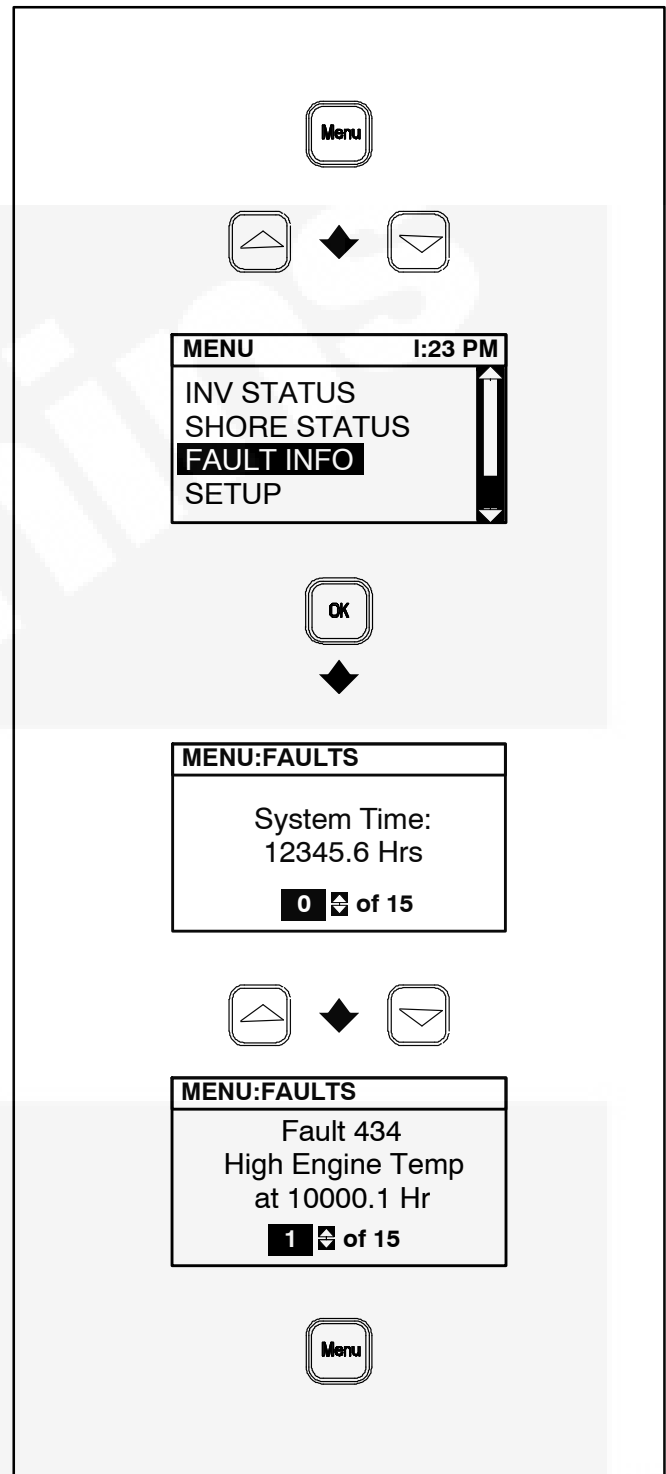

FIGURE A-13. FAULT INFORMATION

## SETUP MENU

Selecting **SETUP** takes you to a second-level menu.

Press **Menu**.

Press **Up** or **Down** to select **SETUP**.

Press **OK**.

Press **Up** or **Down** to select one of the following from the **SETUP** sub-menu:

- **AUTO SETUP**
- **SHORE BREAKER**
- **SCREEN SETUP**
- **SERVICE** (Selecting **SERVICE** takes you to a third-level menu.)

Press **OK** to accept the selection. See the following pages for details about each menu item.

Or, press **Menu** one or more times to go back to the home screen.

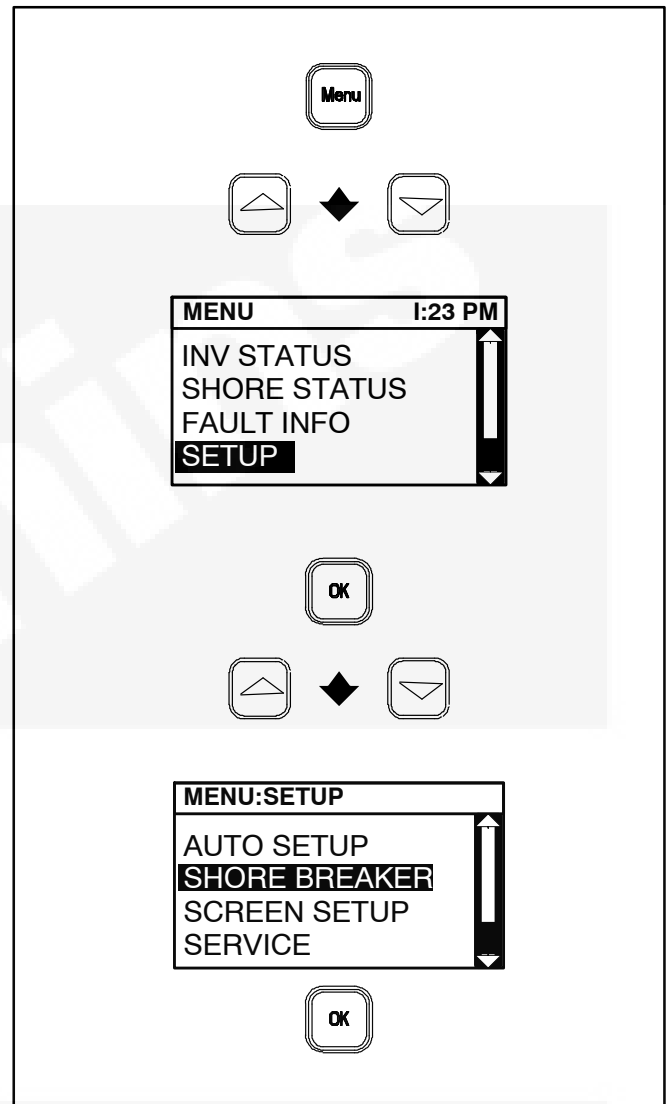

FIGURE A-14. SETUP MENU ITEMS





## SHORE BREAKER

The Hybrid Power System senses whether the coach has been connected to a 50 amp shore power receptacle or to a 30 amp or smaller shore power receptacle through an adapter plug. See the SHORE POWER DETECTED prompt on Page A-25.

Because the Hybrid Power System can draw up to 21 amps of AC during heavy battery charging (42 amps if Model 1218), shore power circuit breaker tripping at the pole could become a nuisance, especially if you connected the coach to a shore power service of less than 30 amps. By entering a smaller Breaker Size on the SHORE setup screen, maximum battery charging is reduced, resulting in less overall AC current draw through the shore power breaker on the pole. This could reduce the frequency of tripping.

Press **Menu**.

Press **Up** or **Down** to select SETUP.

Press **OK**.

Press **Up** or **Down** to select SHORE BREAKER.

Press **OK**.

Press **Up** or **Down** to increment the breaker size. Choices are 15A, 20A, 30A and 50A.

**Note: The smaller the breaker size selected the longer it will take to recharge the Coach Batteries.**

Press **OK** to accept the selection and go back to the home screen.

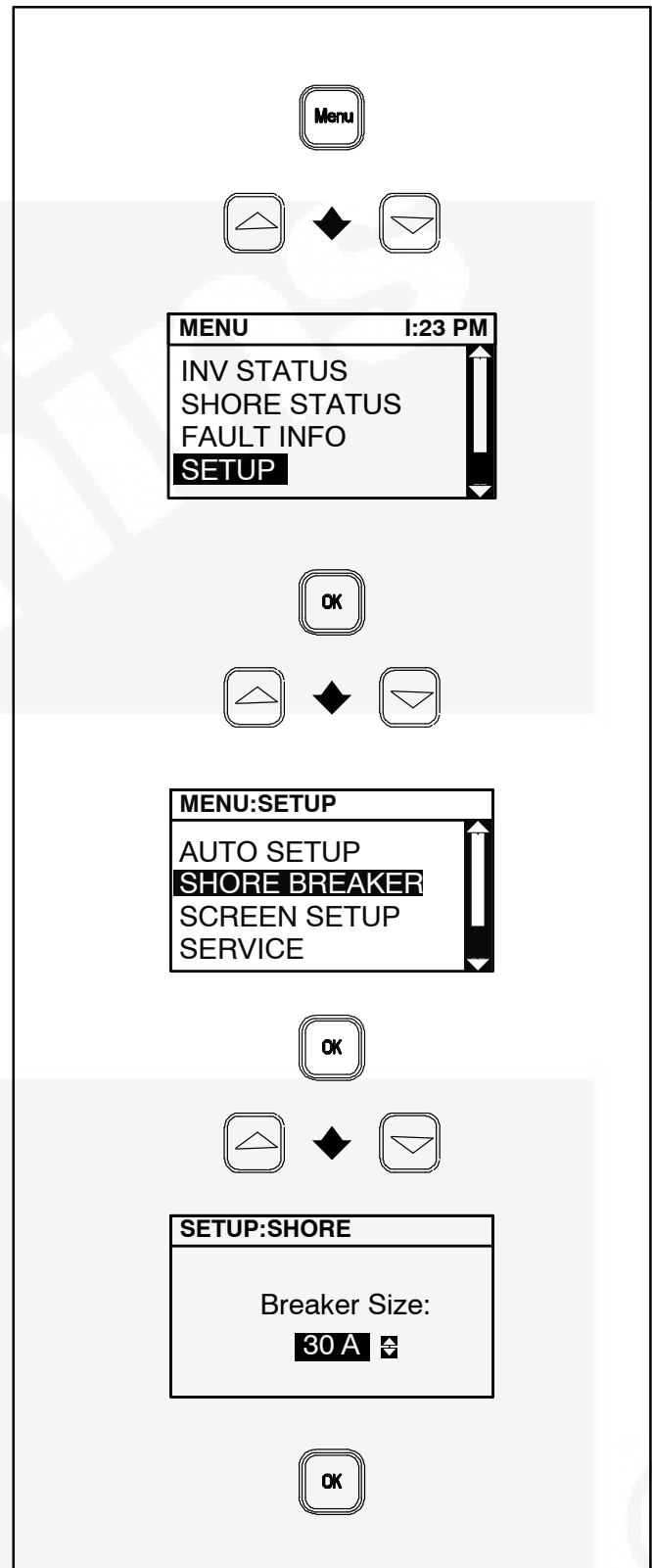

FIGURE A-16. SHORE BREAKER SETUP

## SCREEN SETUP

This feature enables the user to set the Contrast and Brightness of the Operator Panel screen and the length of time the screen backlight stays on after the last touch.

Press **Menu**.

Press **Up** or **Down** to select SETUP.

Press **OK**.

Press **Up** or **Down** to select SCREEN SET UP.

Press **OK**.

Press **Up** or **Down** to select Contrast, Brightness or Timer.

Press **OK**.

Press **Up** or **Down** to change Contrast, Brightness or Timer.

Press **OK** to accept the settings and go back to the home screen.

The bar graphs indicate how much of the available Contrast or Brightness is being used.

The Backlight Timer can be set for 10 to 250 seconds, or turned off.

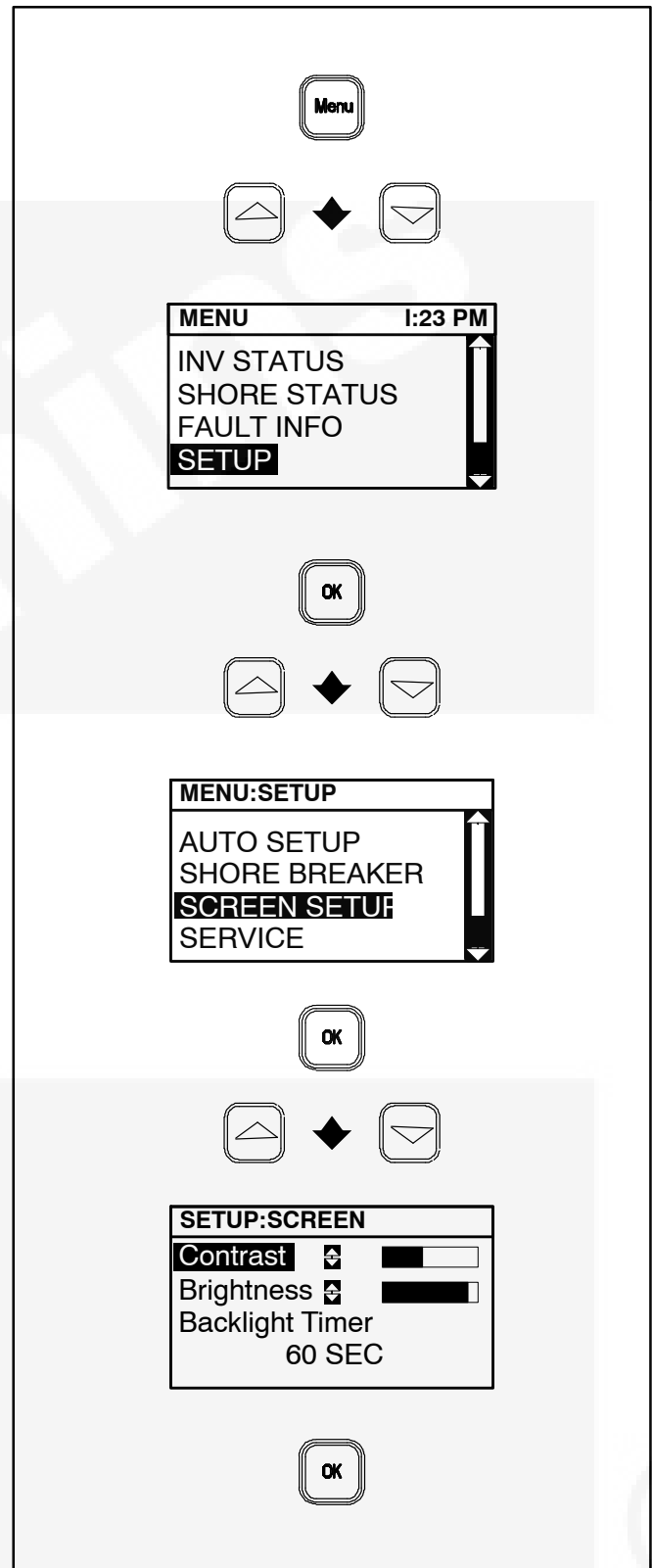

FIGURE A-17. SCREEN SETUP

## SERVICE MENU

Selecting SERVICE takes you to a third-level menu. This is the third-level menu—procedures for those who are trained and experienced in the installation and service of Hybrid Power Systems.

Press **Menu**.

Press **Up** or **Down** to select the SETUP menu.

Press **OK**.

Press **Up** or **Down** to select the SERVICE menu.

Press **OK**.

Press **Up** or **Down** to select one of the following from the SERVICE menu:

- INPUT SETUP
- BATTERY SETUP
- EQUALIZE
- ABOUT

Press **OK** to accept the selection. See the following pages for details about each menu item.

Or, press **Menu** one or more times to go back to the home screen.

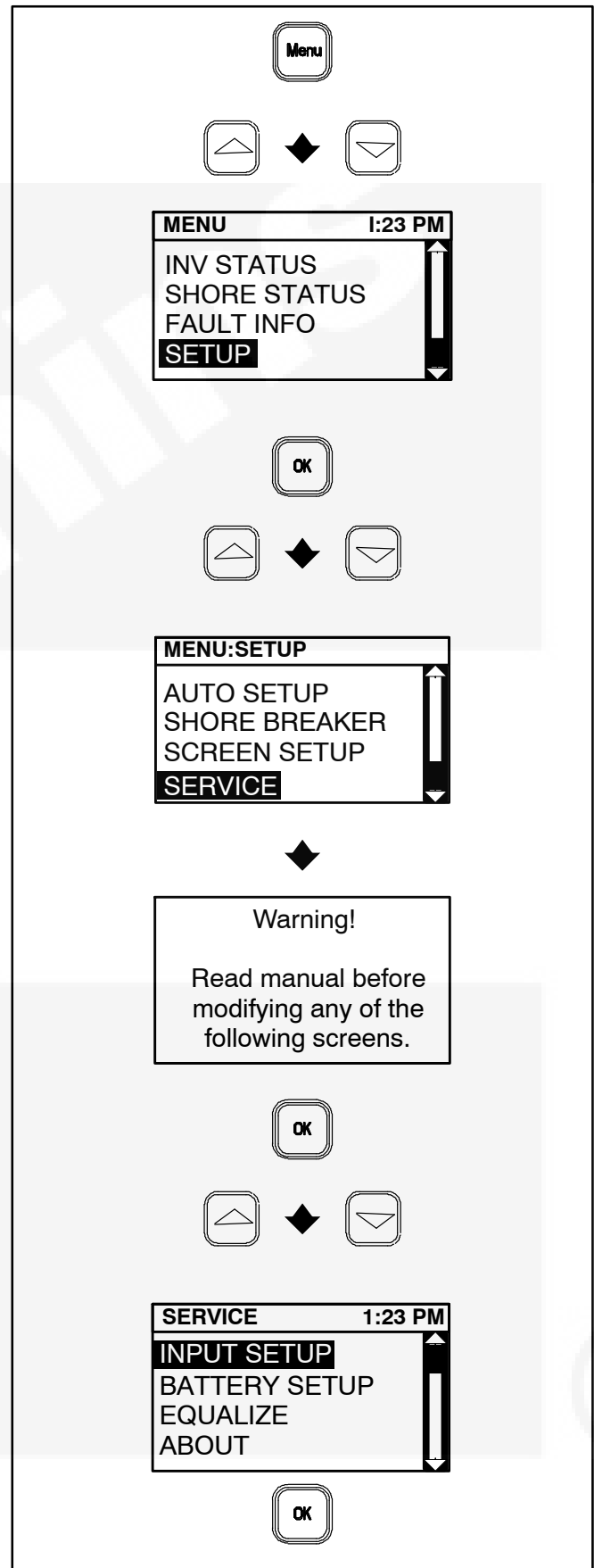
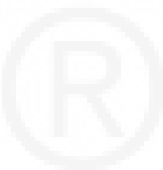

FIGURE A-18. SERVICE MENU ITEMS

## INPUT SETUP

**⚠ CAUTION** *Entering wrong values for Input Setup can lead to unexpected operation.*

Input Setup has installation procedures to be performed only by those trained and experienced in the installation and service of Hybrid Power Systems.



## BATTERY SETUP

Press **Up** or **Down** to select BATTERY SETUP on the SERVICE menu.

Press **OK** to accept.

Press **Up** or **Down** to increment the value.

Press **OK** to accept the value and go to next field.

Press **Menu** one of more times to go back to the home screen after all battery parameters have been configured.

### Type

The Hybrid Power System has default charging parameters for the following types of batteries:

- Wet Cell
- Gel
- AGM

**CAUTION** *Mismatching TYPE with the installed coach batteries can lead to short battery life, resulting in loss of Hybrid Power System performance and availability.*

### Capacity

**Note:** The BATTERY screen pops up with “0” in the Capacity field on startup if a value for Capacity has not been selected.

First determine the rated capacity of the installed coach batteries using the “20 Hour Battery Rating.” See *Appendix D. Battery Connections* on how to connect batteries to obtain the required Coach Battery Capacity (AHRS).

Pressing the Up button causes the values to increment from 0 to 380 and then up in increments of 20. Pressing the Down button causes the values to increment from 0 to 2000 and then down in increments of 20. The Hybrid Power System computes time remaining, time to charge and other battery parameters based on this value.

See *Section E. Specifications* for minimum battery capacity.

**CAUTION** *Unless CAPACITY matches capacity of installed coach batteries, battery charging will be unpredictable, resulting in loss of Hybrid Power System performance and availability.*

### Low Warning

This is percentage of useable battery charge left when the the Low Battery warning light comes on.

### Charger

Leave Charger ON. Turn OFF for service only.

The Charger field also indicates the current mode of charging: Blk – Bulk; Abs – Absorption; Flt – Float; or Eq| – Equalize.

**CAUTION** *Leaving Charger OFF can disable the Hybrid Power System due to discharged batteries.*

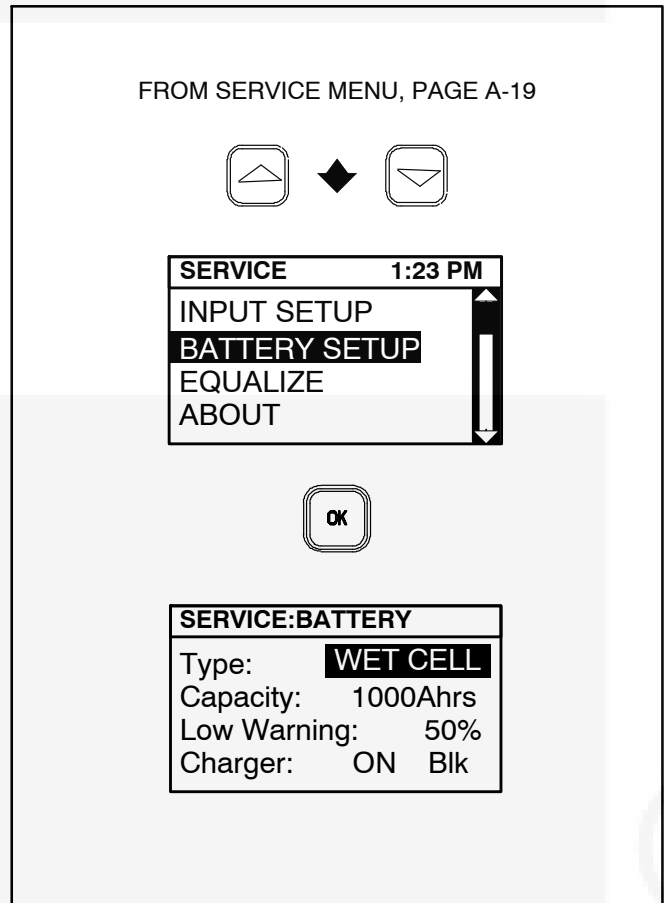

FIGURE A-19. BATTERY SETUP SCREEN

## EQUALIZE

### Safety Precautions

**⚠ WARNING** *Lead-Acid Batteries produce explosive hydrogen gas that can lead to severe personal injury. Do not smoke near batteries. Wear safety glasses. Keep sparks and other sources of ignition away.*

**⚠ CAUTION** *Turn the Coach DC Disconnect Switch to its Disconnect position to prevent damage from high equalizing voltage. Liability for damage to appliances left connected is the sole responsibility of the person performing equalizing.*

1. Turn the Coach DC Disconnect Switch to its Disconnect position before equalizing to prevent damage to appliances from the high equalizing voltage.
2. Equalizing causes water to evaporate from the battery cells. Add just enough distilled water before and after equalizing to cover the tops of the battery plates.
3. Open up the battery compartment as much as possible for better cooling and ventilation.
4. Batteries must be attended while equalizing. Be prepared to stop charging if a battery cell overflows, splits or cracks.
5. *It can take up to 6 hours to equalize the batteries.* Batteries must be attended while equalizing. Someone who has read and understood these instructions must be present to press STOP EQUALIZE if a battery overheats or a cell overflows, splits or cracks.

### Start Equalize

Equalizing is enabled only when the Hybrid Power System is configured for Wet Cell batteries. EQUALIZE will not otherwise appear on the Service Menu.

**Note:** Shore power must be connected, the batteries must be fully charged and AUTO must be disabled. If the batteries are not fully charged the EQUALIZE screen will notify you that they must be full charged (Figure A-22).

Press **Up** or **Down** to select EQUALIZE on the SERVICE menu.

Press **OK** to Start EQUALIZE only after you have read these instructions, have determined that it is safe to equalize and are prepared to press STOP EQUALIZE if necessary.

Charging current will ramp up to 5 percent of coach battery capacity. (For example, the charging current for a 400 AHR battery bank would ramp up to 20 amps DC.) Once equalize voltage is reached (15.5 V), it is held for 30 minutes and the time remaining is recalculated. The total charging time, including up to 30 minutes for cooling, will not exceed 6 hours.

**Note:** START changes to STOP on this screen when Equalize starts.

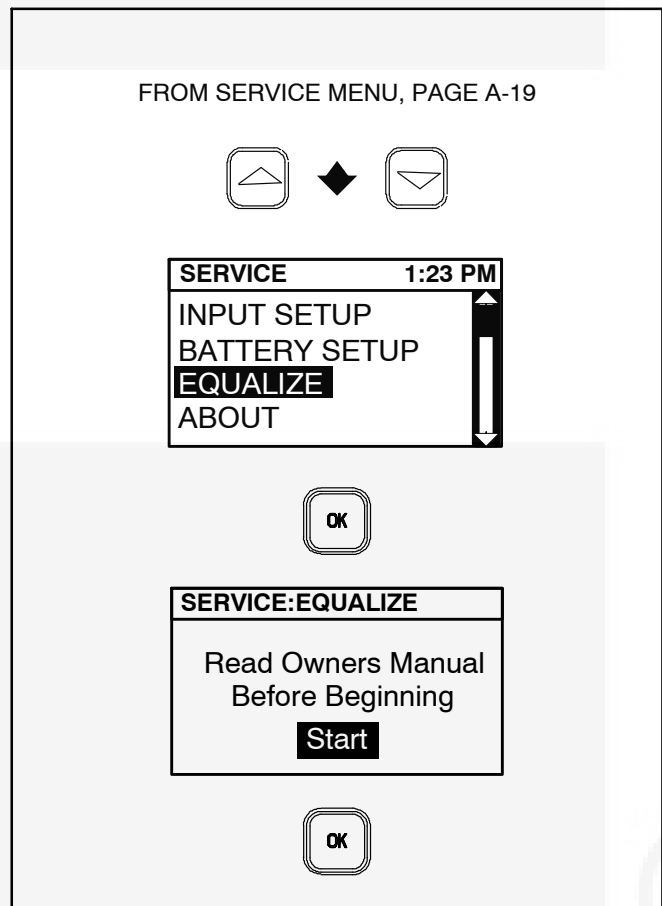

FIGURE A-20. START EQUALIZE SCREEN

## STOP Equalize

Press **OK** to Stop EQUALIZE at any time. Batteries must be attended while equalizing. Be prepared to stop charging if a battery cell overflows, splits or cracks.

Normally, let equalize continue until it times out. A Time Remaining of 6 hours will be posted when EQUALIZE begins.

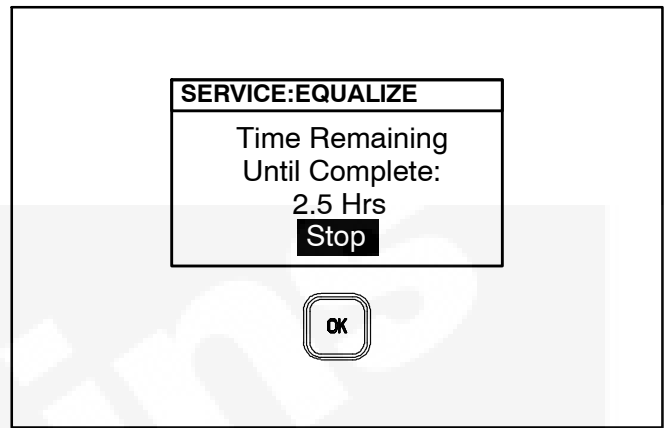

FIGURE A-21. STOP EQUALIZE SCREEN

## If Batteries Are Not Fully Charged

If the batteries are not fully charged the EQUALIZE screen will notify you that they must be fully charged before equalizing. Press **OK** to disable Equalize Charging and connect shore power or start Generator Mode to fully charge the batteries.

**Note:** Equalize charging, once the batteries are fully charged, can take place only when shore power is connected.

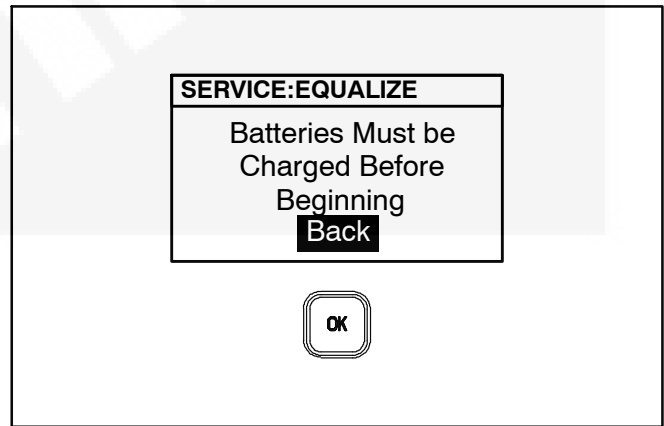

FIGURE A-22. NOT FULLY CHARGED SCREEN



## ABOUT

Use these screens to find out the software part and version numbers of the components of the Hybrid Power System. You may be asked to provide these numbers when you call for service.

Press **Up** or **Down** to select ABOUT on the SERVICE menu.

Press **OK** to accept the selection.

Press **Up** or **Down** to select the component for which you need the software numbers.

Press **Menu** one or more times to go back to the home screen.

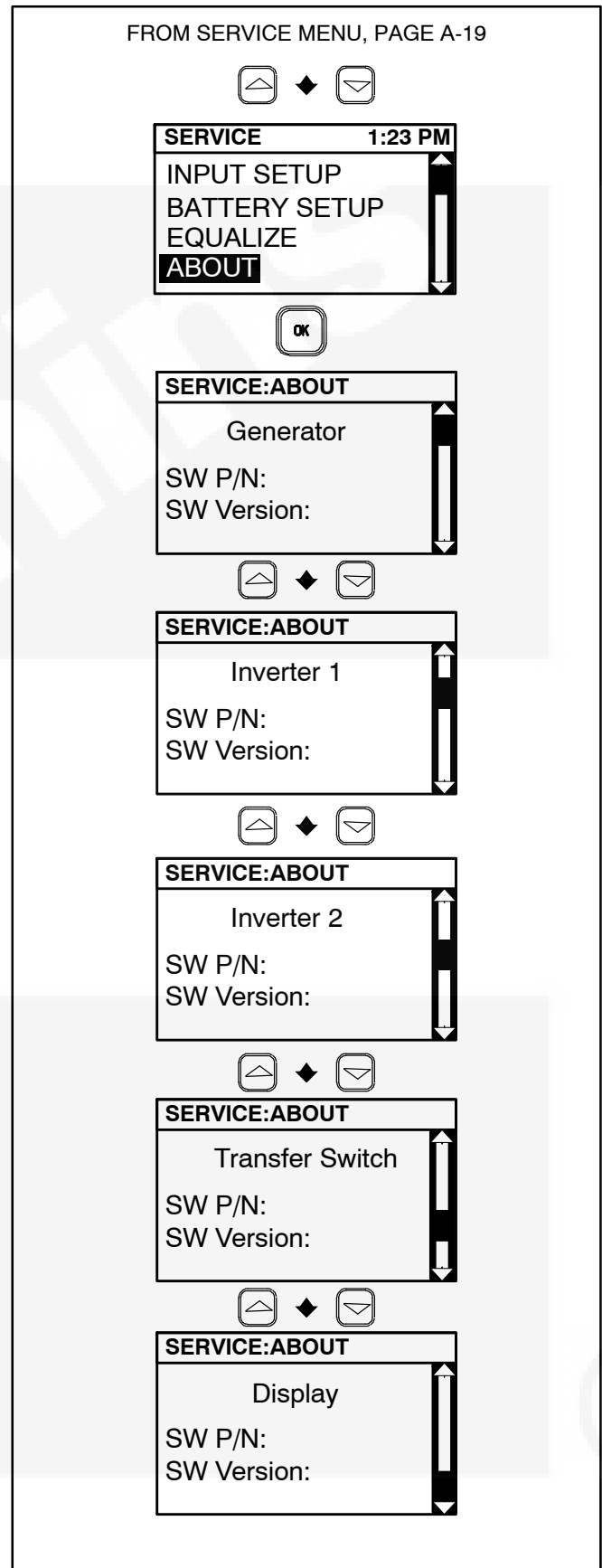

FIGURE A-23. ABOUT SCREEN

## WARNING AND PROMPT SCREENS

Various warning and prompt screens may appear on the Operator Panel when the Hybrid Power System is operating.

### Shore Power Detected

The SHORE POWER DETECTED prompt appears to confirm connection to shore power and prompt you to reset Breaker Size, if necessary (Figure A-24). The prompt times out in 10 minutes.

Press **Up** or **Down** to increment the breaker size. Choices are 10A, 15A, 20A, 30A and 50A.

Press **OK** to accept.

See SHORE BREAKER (p. A-17) for reasons for resetting Breaker Size.

### Shore Quality Warning

If there is a loss or degradation of shore power, the SHORE QUALITY WARNING (Figure A-25) appears indicating the time of the disturbance and one of the following disturbances:

- Overfrequency
- Underfrequency
- Reverse Polarity
- High Voltage
- Low Voltage
- Loss of Neutral
- Loss of L1
- Loss of L2

See *Appendix E. Specifications* regarding acceptable shore power.

Press **OK** to continue operation with shore power and clear the screen. See SHORE STATUS (p. A-13) if the screen was cleared and it is necessary to review shore status. Call the shore power supplier for service if shore quality warnings persist.

**⚠WARNING** *Faulty electrical repairs can lead to severe personal injury or death. Connections and repairs must be made by a trained and experienced electrician in accordance with applicable electrical codes.*

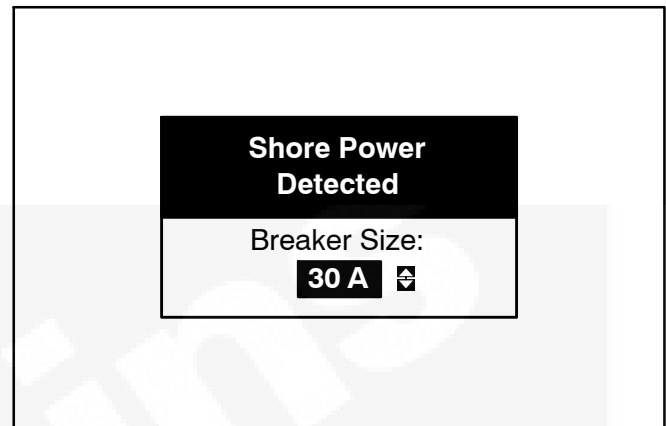

FIGURE A-24. SHORE POWER DETECTED

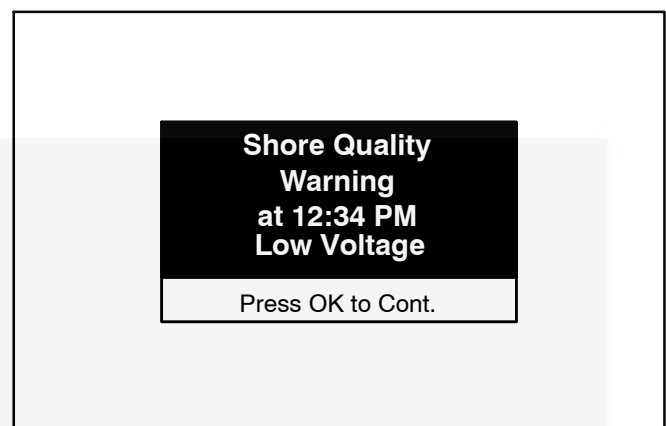

FIGURE A-25. SHORE QUALITY WARNING

## Fault

If a warning or shutdown fault occurs in the Hybrid Power System, a FAULT warning appears (Figure A-26) with the following information:

- The three-digit Warning or Fault Code Number
- The time of occurrence of the warning or fault
- Brief description of the warning or fault

Press **OK** to continue and see *Appendix C. Troubleshooting Fault Codes*.

The FAULT warning does not time out.

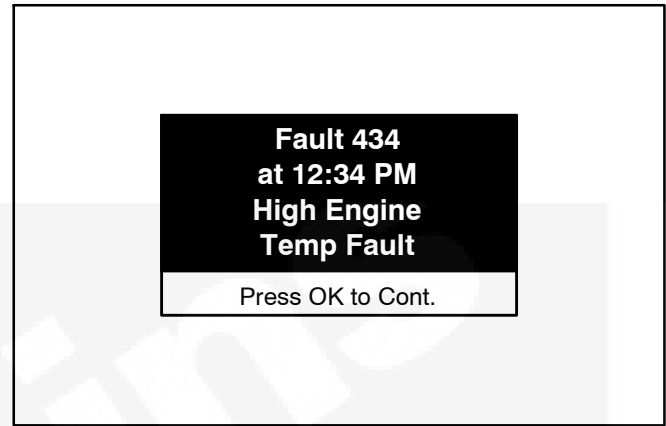

**FIGURE A-26. FAULT WARNING**

## Auto Expiration

The AUTO safety input signal device must be cycled ON and OFF every 30 days to make sure it is still working. After 25 days a prompt appears that AUTO will expire in 5 days (Figure A-27). The countdown continues each subsequent day unless the safety input signal is cycled.

Press **OK** to move to the screen that identifies the safety input signal device your coach was set up to use. Cycle this signal device ON and OFF to reset AUTO for another 30 days. One of the following will be identified as the signal device set up for your coach:

- Brake Signal – With foot on the Brake, release and reset the Parking Brake to cycle the safety signal.
- Ignition Signal – Turn the Ignition Key to the accessory position and back to OFF to cycle the safety signal.
- Park Signal – With foot on the Brake, push the Transmission Shift Lever out of Park and back into Park to cycle the safety signal.

If the AUTO safety input signal has not been cycled ON and OFF for 30 days or more, the Safety Input Expired prompt appears indicating that the signal has expired (Figure A-28). Cycle the safety signal ON and OFF to restore the signal for another 30 days.

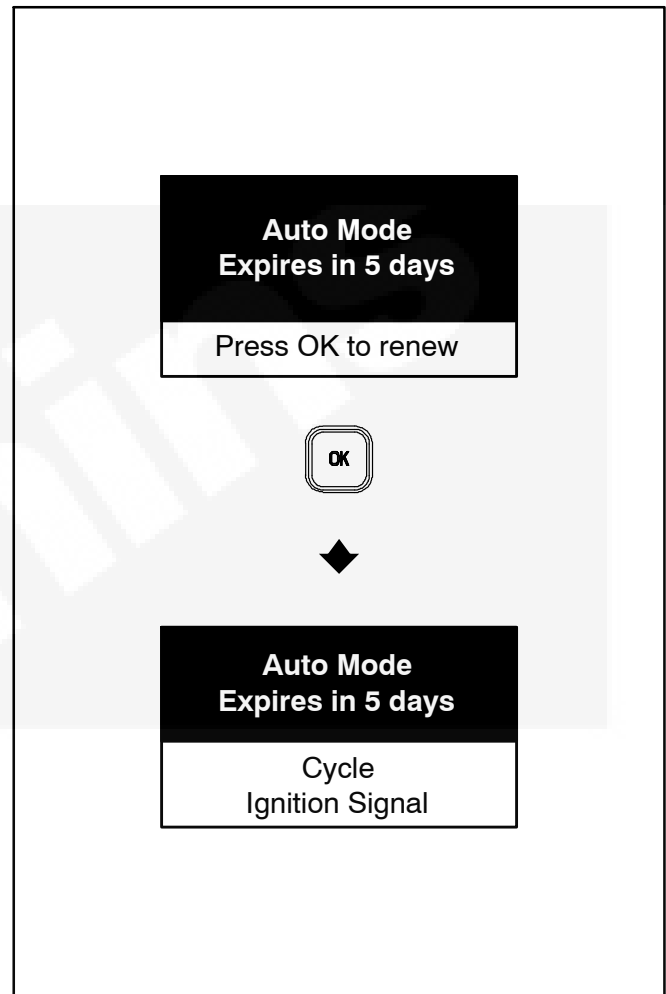

FIGURE A-27. AUTO TO EXPIRE

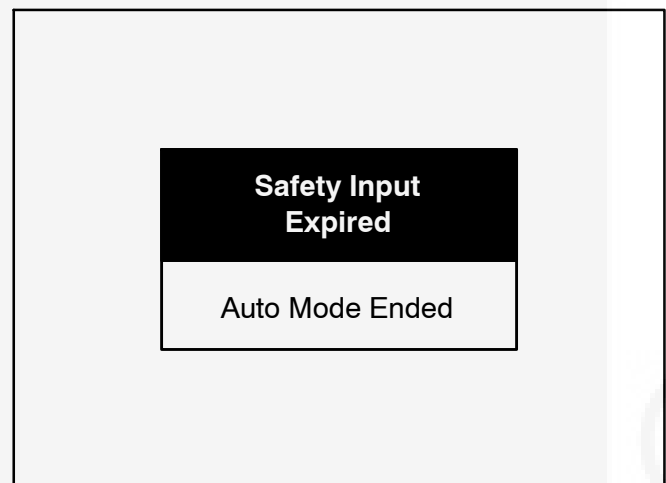
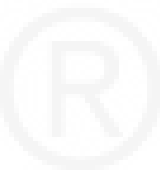

FIGURE A-28. AUTO EXPIRED



**THIS PAGE LEFT INTENTIONALLY BLANK**



# Appendix B. Troubleshooting Symptoms

## TROUBLESHOOTING SYMPTOMS

This section covers step-by-step repair suggestions for directly observable fault symptoms when no system diagnostic fault codes appear.

See *Section C. Troubleshooting Using Fault Codes* for step-by-step repair suggestions when system diagnostic fault codes do appear.

**Note:** Many Hybrid Power System shutdowns related to the Power Unit can be avoided by performing periodic maintenance on schedule (TABLE 3-2. PERIODIC MAINTENANCE SCHEDULE) and by *not* running the Power Unit out of fuel. Note that when the Power Unit and coach engine draw from the same fuel tank, the fuel dip tubes are usually arranged so that the Power Unit will run out of fuel first. By marking the empty point for the Power Unit on the fuel gauge, it will be easier to tell when the Power Unit may run out of fuel.

### FAULT CODE BLINKING

At fault shutdown, the status indicator light will repeatedly blink sets of 1, 2, 3 or 4 blinks.

- **One blink** indicates shutdown due to high engine coolant temperature.
- **Two blinks** indicate shutdown due to a loss of engine oil pressure.
- **Three blinks** indicate a service fault. Press **Stop** once to cause the two-digit, second-level shutdown code to blink. (Pressing **Stop** again will stop the blinking.) The two-digit code consists of 1, 2, 3, 4 or 5 blinks, a brief pause, and then 1 to 9 blinks. The first set of blinks represents the tens digit and the second set of blinks the units digit of the shutdown code number. For example, **shutdown code No. 36** appears as:

blink-blink-blink—*pause*—blink-blink-blink-blink-blink-blink—  
*long pause*—repeat

- **Four blinks** indicate that cranking time exceeded 35 seconds.

- *Fault Code Nos. 1, 2, 3, and 4 are first level faults. Pay close attention to the pause sequence to avoid interpreting first level faults as second-level Fault Codes Nos. 11, 22, 33, or 44.*

- *To avoid the possibility of anyone misinterpreting Code Nos. 3 and 4 as Code Nos. 33 and 44, the latter have not been assigned faults.*

### RESTORING FAULT CODE BLINKING

The fault code stops blinking after five minutes. Press **Stop** three times within three seconds to restore fault code blinking.

**Note:** The last fault logged will blink even though the condition that caused the shutdown may have been corrected.

### GETTING HELP

Contact an authorized Cummins Onan dealer if you are unable to resolve the problem after taking the corrective actions suggested. See HOW TO OBTAIN SERVICE (p. 1-3).



**THIS PAGE LEFT INTENTIONALLY BLANK**

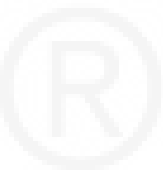

**⚠WARNING** *Some Hybrid Power System service procedures present hazards that can result in severe personal injury or death. Only trained and experienced service personnel with knowledge of fuels, electricity, and machinery hazards should perform Hybrid Power System service.*

### **POWER UNIT WON'T STOP RUNNING—STATUS INDICATOR LIGHT ON**

#### **Possible Cause**

1. Faulty Start/Stop switch.
2. Faulty ground connection.

#### **Repair Suggestions**

Try stopping the Power Unit by squeezing off the fuel supply hose at the Power Unit.

### **POWER UNIT WON'T STOP RUNNING—STATUS INDICATOR LIGHT OFF**

#### **Possible Cause**

1. Binding governor mechanism.
2. Misadjusted actuator.

#### **Repair Suggestions**

Try stopping the Power Unit by squeezing off the fuel supply hose at the Power Unit.

### **STATUS INDICATOR LIGHT ON THE POWER UNIT STAYS ON**

#### **Possible Cause**

Batteries are not connected correctly.

#### **Repair Suggestions**

Reconnect batteries correctly.

### **STATUS INDICATOR LIGHT IS DEAD**

#### **Possible Cause**

1. No battery voltage.
2. Faulty switch or wiring.

#### **Repair Suggestions**

1. Connect batteries.
2. Try starting the Power Unit at its control panel if the Operator Panel or remote Start/Stop switch does not work, and vice versa.

### **POWER UNIT RUNNING (GENERATOR LIGHT ON), BUT NO AC OUTPUT**

#### **Possible Cause**

A circuit breaker in the coach distribution panel has tripped or is OFF.

#### **Repair Suggestions**

Reset or turn on the coach distribution panel circuit breaker.



**⚠WARNING** *Some Hybrid Power System service procedures present hazards that can result in severe personal injury or death. Only trained and experienced service personnel with knowledge of fuels, electricity, and machinery hazards should perform Hybrid Power System service.*

## **BATTERIES RUN DOWN**

### **Possible Cause**

1. Faulty battery connections.
2. Charger turned off.
3. Parasitic loads.
4. Worn out batteries

### **Repair Suggestions**

1. Check battery connections.
2. Charge batteries if necessary.
3. Turn Charger On using Operator Panel (p. A-21).

## **ENGINE CRANKS WHEN BATTERY IS CONNECTED**

### **Possible Cause**

1. Faulty Start/Stop switch.
2. Faulty ground connection.
3. Faulty starter solenoid.

### **Repair Suggestions**

Contact an authorized Cummins Onan dealer.

## **ENGINE WON'T CRANK BUT THE FUEL PUMP IS RUNNING**

### **Possible Cause**

1. Faulty Start/Stop switch.
2. Faulty ground connection.
3. Faulty starter.

### **Repair Suggestions**

Try starting Power Unit at its control panel if the remote Start/Stop switch does not work, and vice versa.

## **POWER UNIT IS HARD TO START**

### **Possible Cause**

1. Low fuel supply or air in fuel lines.
2. Dirty air filter or blocked air inlet or exhaust.
3. High altitude.

### **Repair Suggestions**

1. Fill up with fuel as necessary and prime for at least one minute.
2. Check air intake and exhaust for blockage and replace air filter as necessary.

**⚠WARNING** *Some Hybrid Power System service procedures present hazards that can result in severe personal injury or death. Only trained and experienced service personnel with knowledge of fuels, electricity, and machinery hazards should perform Hybrid Power System service.*

## POWER UNIT SMOKES

### Possible Cause

1. White smoke:
  - A. Cold engine.
  - B. Air in fuel lines.
2. Black smoke:
  - A. Dirty air filter or blocked air inlet or exhaust.
  - B. Over fueling.
3. Blue smoke: Worn pistons and/or rings.

### Repair Suggestions

1. Smoke is normal if it clears up immediately. Avoid running at No-Load.
2. Fill up with fuel as necessary and prime for at least one minute if there is white smoke.
3. Check air intake and exhaust for blockage and replace air filter as necessary if there is black smoke.
4. Contact an authorized Cummins Onan dealer if smoke does not clear up immediately.

## POWER UNIT HUNTS/SURGES UNDER FULL LOAD

### Possible Cause

1. Low fuel supply or air in fuel lines.
2. Dirty air filter or blocked air inlet or exhaust.

### Repair Suggestions

1. Reduce loads if at high ambient temperatures or elevation.
2. Fill up with fuel as necessary and prime for one minute.
3. Check air intake and exhaust for blockage and replace air filter as necessary.

## ENGINE HAS EXCESSIVE OIL CONSUMPTION

### Possible Cause

1. Too much oil.
2. Missing oil fill cap.

### Repair Suggestions

1. Check oil level and drain excess oil.
2. Replace missing oil fill cap.

## POWER UNIT STARTS OR STOPS WITHOUT START/STOP COMMAND

### Possible Cause

1. System is in Auto (normal).
2. Faulty grounding.
3. Faulty Start/Stop switch.

### Repair Suggestions

1. Disable AUTO if normal starting is not desired.
2. Try starting/stopping Power Unit at its control panel if the remote Start/Stop switch does not work, and vice versa.

**⚠WARNING** *Some Hybrid Power System service procedures present hazards that can result in severe personal injury or death. Only trained and experienced service personnel with knowledge of fuels, electricity, and machinery hazards should perform Hybrid Power System service.*

## **OPERATOR PANEL WON'T POWER ON**

### **Possible Cause**

1. The Coach DC Disconnect Switch is in its Disconnect position and Shore Power is not available or connected.
2. Battery charge is too low.

### **Repair Suggestions**

1. Turn the Coach DC Disconnect Switch to Connect or connect Shore Power.
2. Cycle the Hybrid Power System by disconnecting Shore Power (if connected) and turning the Coach DC Disconnect Switch to Disconnect. Wait 10 seconds and then turn it back to Connect.
3. Check battery voltage. Charge/Replace if necessary.

## **OPERATOR PANEL SCREEN IS TOO DARK/LIGHT**

### **Possible Cause**

1. Contrast setting needs to be adjusted.
2. Extreme ambient temperatures.

### **Repair Suggestions**

1. Adjust contrast settings.
2. Ambient temperature may be too high or too low to turn on the pixels. Wait until temperatures are normal.

## **OPERATOR PANEL IS MISSING LINES OF DATA**

### **Possible Cause**

Normal 3 to 5 second delay.

### **Repair Suggestions**

Contact an authorized Cummins Onan dealer if lines do not appear.

## **CANNOT TURN POWER UNIT ON / OFF FROM OPERATOR PANEL**

### **Possible Cause**

1. Engine preheating (normal).
2. Coach DC Disconnect Switch is in its Disconnect position.

### **Repair Suggestions**

1. Wait up to 20 seconds for engine preheating (glow plugs) to finish.
2. Turn the Coach DC Disconnect Switch to Connect.

## **CANNOT TURN INVERTER / CHARGER ON OR OFF FROM OPERATOR PANEL**

### **Possible Cause**

The Coach DC Disconnect Switch is in its Disconnect position and Shore Power is not connected.

### **Repair Suggestions**

Turn the Coach DC Disconnect Switch to Connect and connect Shore Power.

**⚠WARNING** *Some Hybrid Power System service procedures present hazards that can result in severe personal injury or death. Only trained and experienced service personnel with knowledge of fuels, electricity, and machinery hazards should perform Hybrid Power System service.*

## **“ESTABLISHING COMMUNICATION WITH CONTROL” STAYS ON OPERATOR PANEL**

### **Possible Cause**

Communication wire between Operator Panel and Transfer Switch is missing or loose.

### **Repair Suggestions**

Cycle the Hybrid Power System by disconnecting Shore Power (if connected) and turning the Coach DC Disconnect Switch to Disconnect. Wait 10 seconds and then turn it back to Connect.

## **SHORE BREAKER KEEPS TRIPPING**

### **Possible Cause**

1. Shore breaker size set too high.
2. Too many loads

### **Repair Suggestions**

1. Reset breaker size using Operator Panel (p. A-17).
2. Reduce the number of loads.

## **HIGH OR UNUSUAL BATTERY CHARGE/DISCHARGE ON BATTERY STATUS SCREEN**

### **Possible Cause**

Shunt fuse blown.

### **Repair Suggestions**

Replace the blown shunt fuse (p. 6-6).

## **BATTERY VOLTAGE HIGH AND FLUCTUATES IN GENERATOR OR SHORE MODE**

### **Possible Cause**

Battery fuse blown.

### **Repair Suggestions**

Replace the blown battery fuse (p. 6-6).

## **BATTERY VOLTAGE LOW WHEN GENERATOR OR SHORE MODE STOPPED**

### **Possible Cause**

Battery fuse blown.

### **Repair Suggestions**

Replace the blown battery fuse (p. 6-6).

# Appendix C. Troubleshooting Fault Codes

---

## FAULT CODES

This section covers step-by-step repair suggestions when system diagnostic fault codes appear. The faults are listed in numeric order. If a warning or shutdown fault occurs, a warning appears on the Operator Panel with a brief description of the warning or shutdown fault, the three-digit code number and the time of occurrence (p. A-26).

See *Section B. Troubleshooting Symptoms* for step-by-step repair suggestions when there is a shutdown but no system diagnostic fault code appears.

The component that detects the system fault—whether Inverter/Charger, Transfer Switch or Power Unit—also flashes the last two digits of the numeric fault code.

1. **Single-Inverter/Charger Hybrid Power Systems:** The Inverter/Charger light flashes the 100 level faults
2. **Dual-Inverter/Charger Hybrid Power Systems:** The **Primary** Inverter/Charger light flashes the 100 level faults; The **Secondary** Inverter/Charger light flashes the 200 level faults
3. The Transfer Switch light flashes the 300 level faults
4. The Power Unit control switch light flashes the 400 level faults.

**Note:** The Power Unit control switch cannot be used to display fault history. See **FAULT INFORMATION** (p. A-14) on how to display fault history using the Operator Panel.

**Note:** Many Hybrid Power System shutdowns related to the Power Unit can be avoided by performing periodic maintenance on schedule (TABLE 3-2. PERIODIC MAINTENANCE SCHEDULE) and by *not* running the Power Unit out of fuel. Note that when the Power Unit and coach engine draw from the same fuel tank, the fuel dip tubes are usually arranged so that the Power Unit will run out of fuel first. By marking the empty point for the Power Unit on the fuel gauge, it will be easier to tell when the Power Unit may run out of fuel.

## GETTING HELP

Contact an authorized Cummins Onan dealer if you are unable to resolve the problem after taking the corrective actions suggested. See **HOW TO OBTAIN SERVICE** (p. 1-3).





**THIS PAGE LEFT INTENTIONALLY BLANK**

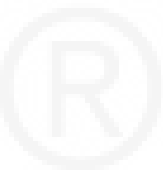

**⚠WARNING** *Some Hybrid Power System service procedures present hazards that can result in severe personal injury or death. Only trained and experienced service personnel with knowledge of fuels, electricity, and machinery hazards should perform Hybrid Power System service.*

### **FAULT NO. 112/212—AC OUTPUT OVER VOLTAGE**

#### **Possible Cause**

1. Very large AC loads dropped quickly—8 kW step or greater.
2. Defective Inverter/Charger component.

#### **Repair Suggestion**

1. Reduce AC loads.
2. Cycle the Hybrid Power System by disconnecting Shore Power (if connected) and turning the Coach DC Disconnect Switch to Disconnect. Wait 10 seconds and then turn it back to Connect.

### **FAULT NO. 113/213—AC OUTPUT UNDER VOLTAGE**

#### **Possible Cause**

1. Very large AC transient load—8 kW step or greater.
2. System overloads:
  - A. In Inverter Mode, loads greater 3kW.
  - B. In Generator Mode, loads greater than 10kW.
3. Low PMA voltage or Engine Power.
4. Defective Inverter/Charger component.
5. Blown battery Fuse (400 Amp) . Indicated by dead operator panel. Only Shore Mode works.

#### **Repair Suggestion**

1. Turn the air conditioning thermostat OFF, restart Generator Mode or connect Shore Power, and then turn the thermostat ON again. (This resets the thermostat so that it will start the air conditioners in sequence rather than all at once, greatly reducing the AC transient load on the Hybrid Power System.)
2. Reduce AC loads to see whether problem persists.

### **FAULT NO. 114/214—LOSS OF SYNCHRONIZATION**

#### **Possible Cause**

1. Secondary/Primary Inverter/Charger shut down without issuing a fault.
2. Communications cable is faulty or missing.
3. Extremely unbalanced loads between the primary & secondary inverters will lead to synchronization issue or Fault Code 114/214.

#### **Repair Suggestion**

Contact an authorized Cummins Onan dealer.

### **FAULT NO. 115/215—INVERTER FAULT**

#### **Possible Cause**

The Inverter/Charger that detected the fault in the other Inverter/Charger also shuts down.

#### **Repair Suggestion**

Contact an authorized Cummins Onan dealer.

**⚠WARNING** *Some Hybrid Power System service procedures present hazards that can result in severe personal injury or death. Only trained and experienced service personnel with knowledge of fuels, electricity, and machinery hazards should perform Hybrid Power System service.*

#### **FAULT NO. 116/216—BOOST OVER TEMPERATURE**

##### **Possible Cause**

1. Insufficient cooling (liquid not air flow).
2. Defective Inverter/Charger component.

##### **Repair Suggestion**

Check the system for coolant leaks.

#### **FAULT NO. 117/217—CHARGER OVER TEMPERATURE**

##### **Possible Cause**

1. Insufficient cooling (liquid not air flow).
2. Defective Inverter/Charger component.

##### **Repair Suggestion**

Check the system for coolant leaks.

#### **FAULT NO. 118/218—INVERTER OVER TEMPERATURE**

##### **Possible Cause**

1. Insufficient cooling (liquid not air flow).
2. Defective Inverter/Charger component.

##### **Repair Suggestion**

Check the system for coolant leaks.

#### **FAULT NO. 119/219—AC OUTPUT SHORT CIRCUIT**

##### **Possible Cause**

1. Loads are too large.
2. External short.
3. Internal Inverter/Charger component has failed.

##### **Repair Suggestion**

Reduce Loads.

#### **FAULT NO. 124/224—BATTERY TEMPERATURE SENSOR FAULT**

##### **Possible Cause**

1. Sensor is disconnected or broken.
2. Sensor or sensor wires are corroded.

##### **Repair Suggestion**

Contact an authorized Cummins Onan dealer.



**⚠WARNING** *Some Hybrid Power System service procedures present hazards that can result in severe personal injury or death. Only trained and experienced service personnel with knowledge of fuels, electricity, and machinery hazards should perform Hybrid Power System service.*

### **FAULT NO. 125/225—HIGH DC BUS VOLTAGE**

#### **Possible Cause**

1. Very large AC loads drop quickly—8 kW step or greater.
2. Engine speeds up too fast under light load.

#### **Repair Suggestion**

Reduce AC load.

### **FAULT NO. 126/226—BOOST TEMPERATURE SENSOR FAULT**

#### **Possible Cause**

Defective Inverter/Charger component.

#### **Repair Suggestion**

If ambient temperatures are extreme, wait until temperatures reach normal range to see whether the problem persists.

### **FAULT NO. 127/227—CHARGER TEMPERATURE SENSOR FAULT**

#### **Possible Cause**

Defective charger component.

#### **Repair Suggestion**

If ambient temperatures are extreme, wait until temperatures become more normal to see whether the problem persists.

### **FAULT NO. 128/228—INVERTER TEMPERATURE SENSOR FAULT**

#### **Possible Cause**

Defective Inverter/Charger component.

#### **Repair Suggestion**

If ambient temperatures are extreme, wait until temperatures become more normal to see whether the problem persists.

### **FAULT NO. 129/229—HIGH BATTERY VOLTAGE**

#### **Possible Cause**

1. Batteries are misconnected.
2. External battery charger or charger connections.

#### **Repair Suggestion**

1. Check battery cables and connections.
2. If an external battery charger is connected, verify connections.

**⚠WARNING** *Some Hybrid Power System service procedures present hazards that can result in severe personal injury or death. Only trained and experienced service personnel with knowledge of fuels, electricity, and machinery hazards should perform Hybrid Power System service.*

### **FAULT NO. 131/231—INVERTER OVER TEMPERATURE**

#### **Possible Cause**

Insufficient air flow.

#### **Repair Suggestion**

Check Inverter/Charger enclosure airflow.

1. Remove bags and other items stored in the enclosure.
2. Remove items blocking the Inverter/Charger air inlet and outlet openings.

### **FAULT NO. 132/232—INVERTER TEMPERATURE SENSOR FAULT**

#### **Possible Cause**

Defective Inverter/Charger component.

#### **Repair Suggestion**

If ambient temperatures are extreme, wait until temperatures become more normal to see whether the problem persists.

### **FAULT NO. 134/234—BOOST CURRENT FAULT**

#### **Possible Cause**

Loads greater than 8kW were rapidly and repeatedly cycled while boosting.

#### **Repair Suggestion**

Reduce AC transient loads.

### **FAULT NO. 135/235—INVERTER PROCESSOR FAULT**

#### **Possible Cause**

1. Inverter/Charger EE memory did not download completely.
2. Inverter/Charger EE memory failed.

#### **Repair Suggestion**

Contact an authorized Cummins Onan dealer.

### **FAULT NO. 136/236—POWER UNIT UNDER VOLTAGE**

#### **Possible Cause**

1. Engine speed did not ramp up fast enough to meet a large transient load.
2. PMA is faulty.
3. Governor actuator is faulty.
4. This occurs under unbalanced load operation in the field.
5. Windings of the primary inverter have voltage sensing capability. 3 phase windings from Power Unit maybe reversely connected to the primary and secondary inverters. This causes the Power Unit to drop the voltage when load was only applied to the primary inverter since the alternator was actually sensing the secondary inverter voltage instead of the primary inverter voltage

#### **Repair Suggestion**

Reduce loads.

**⚠WARNING** *Some Hybrid Power System service procedures present hazards that can result in severe personal injury or death. Only trained and experienced service personnel with knowledge of fuels, electricity, and machinery hazards should perform Hybrid Power System service.*

### **FAULT NO. 137/237—INVALID SYSTEM CONFIGURATION**

#### **Possible Cause**

The system is not configured correctly.

#### **Repair Suggestion**

Contact an authorized Cummins Onan dealer.

### **FAULT NO. 138/238—HIGH AC CURRENT**

#### **Possible Cause**

Too many loads on at once.

#### **Repair Suggestion**

1. Reduce loads.
2. Check loads for short circuits.

### **FAULT NO. 139/239—LOW BATTERY VOLTAGE**

#### **Possible Cause**

1. Loads were greater than 8 kW for too long while running in Inverter Mode.
2. The battery cables are too long.
3. The battery cable connections are miswired, loose or corroded.
4. Charging circuit not functioning.
5. Batteries are wearing out.
6. Blown battery Fuse (400 Amp) . Indicated by dead operator panel. Only Shore Mode works.

#### **Repair Suggestion**

1. Reduce loads.
2. Verify battery connections.
3. Charge batteries.
4. Check battery size.
5. Test batteries.

### **FAULT NO. 141/241—POWER UNIT BREAKER OPEN**

#### **Possible Cause**

1. Breaker on Power Unit is open.
2. There is an open/loose connection between Power Unit and Inverter/Charger.
3. There is an open/loose connection in Power Unit between PMA and circuit breaker.

#### **Repair Suggestion**

Check Power Unit circuit breaker.

**⚠WARNING** *Some Hybrid Power System service procedures present hazards that can result in severe personal injury or death. Only trained and experienced service personnel with knowledge of fuels, electricity, and machinery hazards should perform Hybrid Power System service.*

#### **FAULT NO. 142/242—INVERTER PROCESSOR FAULT**

##### **Possible Cause**

1. Inverter/Charger Program memory did not download completely.
2. Inverter/Charger EE memory failed.

##### **Repair Suggestion**

Contact an authorized Cummins Onan dealer.

#### **FAULT NO. 143/243—INVERTER PROCESSOR FAULT**

##### **Possible Cause**

1. Inverter/Charger Data memory did not download completely.
2. Inverter/Charger EE memory failed.

##### **Repair Suggestion**

Contact an authorized Cummins Onan dealer.

#### **FAULT NO. 145/245—LOSS OF DC BUS VOLTAGE**

##### **Possible Cause**

1. Breaker between Transfer Switch and Inverter/Charger is open.
2. Failed Inverter/Charger component.

##### **Repair Suggestion**

1. In Inverter Mode, check battery connections and voltage.
2. In Shore Mode, check all circuit breakers, and to verify that the Inverter/Charger is able to communicate, cycle the Hybrid Power System by disconnecting Shore Power (if connected) and turning the Coach DC Disconnect Switch to Disconnect. Wait 10 seconds and then turn it back to Connect. Note that it is possible to get fault 176/276 after closing any circuit breakers that may have tripped.

#### **FAULT NO. 146/246—POWER SUPPLY FAULT**

##### **Possible Cause**

1. Faulty wiring.
2. Low Battery Voltage.

##### **Repair Suggestion**

Contact an authorized Cummins Onan dealer.

#### **FAULT NO. 148/248—INVERTER CURRENT SENSOR FAULT**

##### **Possible Cause**

Defective Inverter/Charger component.

##### **Repair Suggestion**

Contact an authorized Cummins Onan dealer.

**⚠WARNING** *Some Hybrid Power System service procedures present hazards that can result in severe personal injury or death. Only trained and experienced service personnel with knowledge of fuels, electricity, and machinery hazards should perform Hybrid Power System service.*

### **FAULT NO. 156/256—INVERTER TEMPERATURE SENSOR FAULT**

#### **Possible Cause**

Defective Inverter/Charger component.

#### **Repair Suggestion**

If ambient temperatures are extreme, wait until temperatures become more normal to see whether the problem persists.

### **FAULT NO. 158/258—HIGH BATTERY TEMPERATURE WARNING**

#### **Possible Cause**

1. Charge/Discharge rate was too high for too long.
2. Battery enclosure does not have sufficient airflow.
3. Corrosion on battery sensor or cables.
4. Bad batteries.

#### **Repair Suggestion**

1. Let batteries cool down.
2. Reduce loads.
3. Verify correct battery type settings.
4. Check battery compartment for airflow.
5. Check connections.
6. Replace batteries.

### **FAULT NO. 162/262—INVERTER FAN WARNING**

#### **Possible Cause**

1. Open/Loose connections (3 wire).
2. Faulty fan.

#### **Repair Suggestion**

Contact an authorized Cummins Onan dealer.

### **FAULT NO. 163/263—BOOST OVER TEMPERATURE**

#### **Possible Cause**

1. Insufficient air flow.
2. Defective Inverter/Charger component.

#### **Repair Suggestion**

Remove load and wait 10 minutes to cool down.

**⚠WARNING** *Some Hybrid Power System service procedures present hazards that can result in severe personal injury or death. Only trained and experienced service personnel with knowledge of fuels, electricity, and machinery hazards should perform Hybrid Power System service.*

#### **FAULT NO. 164/264—BOOST TEMPERATURE SENSOR FAULT**

##### **Possible Cause**

Defective Inverter/Charger component.

##### **Repair Suggestion**

If ambient temperatures are extreme, wait until temperatures become more normal to see whether the problem persists.

#### **FAULT NO. 165/265—BOOST/CHARGER OVER CURRENT FAULT**

##### **Possible Cause**

1. Coolant was very hot when a large load was applied.
2. When the system was boosting, loads greater than 8kw were rapidly and repeatedly cycled.
3. When the system was charging there was a short to battery side of Inverter/Charger.

##### **Repair Suggestion**

1. Check coolant level and repair leaks as necessary.
2. Turn the air conditioning thermostat OFF, restart Generator Mode or connect Shore Power, and then turn the thermostat ON again. (This resets the thermostat so that it will start the air conditioners in sequence rather than all at once, greatly reducing the AC transient load on the Hybrid Power System.)

#### **FAULT NO. 168/268/368/468—UNKNOWN FAULT**

##### **Possible Cause**

The software has not been updated to the proper version.

##### **Repair Suggestion**

Contact an authorized Cummins Onan dealer.

#### **FAULT NO. 171/271—BOOST OVER CURRENT**

##### **Possible Cause**

1. In Inverter Mode: Load greater than 3 kw.
2. In Generator Mode: Load greater than 10 kw.
3. Large transient loads when there are low batteries.
4. Worn out or defective batteries.

##### **Repair Suggestion**

1. Reduce loads.
2. Check battery conditions. Charge/replace if necessary.

#### **FAULT NO. 172/272—INVALID SOFTWARE CONFIGURATION**

##### **Possible Cause**

Inverter/Charger was shipped with functional test software.

##### **Repair Suggestion**

Contact an authorized Cummins Onan dealer.

**⚠WARNING** *Some Hybrid Power System service procedures present hazards that can result in severe personal injury or death. Only trained and experienced service personnel with knowledge of fuels, electricity, and machinery hazards should perform Hybrid Power System service.*

### **FAULT NO. 173/273—CHARGER OUTPUT SHORT CIRCUIT**

#### **Possible Cause**

1. Battery connections or condition.
2. Loads or coach wiring.

#### **Repair Suggestion**

Turn the Coach DC Disconnect Switch to Disconnect:

1. Check battery connections.
2. Check for shorts across battery terminals.
3. Check battery voltage.
4. Check battery condition.

### **FAULT NO. 174/274—BOOST FAULT**

#### **Possible Cause**

1. Alternator short to ground.
2. Low or dead batteries.
3. Blown battery Fuse (400 Amp) . Indicated by dead operator panel. Only Shore Mode works.

#### **Repair Suggestion**

1. Check battery voltage.
2. Charge/Replace batteries if necessary.
3. Replace the blown battery fuse (p. 6-6).

### **FAULT NO. 176/276—CHARGER FAULT**

#### **Possible Cause**

1. AC distribution panel circuit breaker is OFF.
2. There are loose or missing wires between the Inverter/Charger and the AC distribution panel.
3. Missing communication connections between Inverter/Charger (J13) and transfer switch (J2).
4. DC / battery power is not available to inverter/Charger and Transfer Switch.
5. Soft start or resistor in the Inverter/Charger failed.

#### **Repair Suggestion**

Turn the distribution panel circuit breaker ON.

### **FAULT NO. 181/281—COMMUNICATIONS FAULT**

#### **Possible Cause**

Loose or missing connection.

#### **Repair Suggestion**

Cycle the Hybrid Power System by disconnecting Shore Power (if connected) and turning the Coach DC Disconnect Switch to Disconnect. Wait 10 seconds and then turn it back to Connect.

**⚠WARNING** *Some Hybrid Power System service procedures present hazards that can result in severe personal injury or death. Only trained and experienced service personnel with knowledge of fuels, electricity, and machinery hazards should perform Hybrid Power System service.*

### **FAULT NO. 182/282—COMMUNICATION FAULT**

#### **Possible Cause**

1. Loose or missing connection.
2. Failed Inverter/Charger.

#### **Repair Suggestion**

Cycle the Hybrid Power System by disconnecting Shore Power (if connected) and turning the Coach DC Disconnect Switch to Disconnect. Wait 10 seconds and then turn it back to Connect.

### **FAULT NO. 183/283—COMMUNICATION FAULT**

#### **Possible Cause**

1. Loose or missing connection.
2. ECM is asleep.

#### **Repair Suggestion**

Cycle the Hybrid Power System by disconnecting Shore Power (if connected) and turning the Coach DC Disconnect Switch to Disconnect. Wait 10 seconds and then turn it back to Connect.

### **FAULT NO. 184/284—COMMUNICATION FAULT**

#### **Possible Cause**

Loose or missing connection.

#### **Repair Suggestion**

Cycle the Hybrid Power System by disconnecting Shore Power (if connected) and turning the Coach DC Disconnect Switch to Disconnect. Wait 10 seconds and then turn it back to Connect.

### **FAULT NO. 185/285—COMMUNICATIONS FAULT**

#### **Possible Cause**

Loose or missing connection.

#### **Repair Suggestion**

Cycle the Hybrid Power System by disconnecting Shore Power (if connected) and turning the Coach DC Disconnect Switch to Disconnect. Wait 10 seconds and then turn it back to Connect.

### **FAULT NO. 186/286—COMMUNICATIONS FAULT**

#### **Possible Cause**

Loose or missing connection.

#### **Repair Suggestion**

Cycle the Hybrid Power System by disconnecting Shore Power (if connected) and turning the Coach DC Disconnect Switch to Disconnect. Wait 10 seconds and then turn it back to Connect.



**⚠WARNING** *Some Hybrid Power System service procedures present hazards that can result in severe personal injury or death. Only trained and experienced service personnel with knowledge of fuels, electricity, and machinery hazards should perform Hybrid Power System service.*

### **FAULT NO. 187/287—COMMUNICATION FAULT**

#### **Possible Cause**

1. Loose or missing connection.
2. ECM is asleep.

#### **Repair Suggestion**

Cycle the Hybrid Power System by disconnecting Shore Power (if connected) and turning the Coach DC Disconnect Switch to Disconnect. Wait 10 seconds and then turn it back to Connect.

### **FAULT NO. 189/289—COMMUNICATION FAULT**

#### **Possible Cause**

Loose or missing connection.

#### **Repair Suggestion**

Cycle the Hybrid Power System by disconnecting Shore Power (if connected) and turning the Coach DC Disconnect Switch to Disconnect. Wait 10 seconds and then turn it back to Connect.

### **FAULT NO. 191/291—COMMUNICATION FAULT**

#### **Possible Cause**

Loose or missing connection.

#### **Repair Suggestion**

Cycle the Hybrid Power System by disconnecting Shore Power (if connected) and turning the Coach DC Disconnect Switch to Disconnect. Wait 10 seconds and then turn it back to Connect.

### **FAULT NO. 312—POWER UNIT CONTACTOR FAULT**

#### **Possible Cause**

1. Extremely low voltage due to heavy loads or an open breaker.
2. Harness connection or damage.
3. Defective transfer switch component.

#### **Repair Suggestion**

Turn the air conditioning thermostat OFF, restart Generator Mode or connect Shore Power, and then turn the thermostat ON again. (This resets the thermostat so that it will start the air conditioners in sequence rather than all at once, greatly reducing the AC transient load on the Hybrid Power System.)

### **FAULT NO. 313—POWER UNIT CONTACTOR FAULT**

#### **Possible Cause**

1. Contactor welded shut due to high current.
2. Defective transfer switch component.

#### **Repair Suggestion**

Verify that the Power Unit is off, disconnect loads and wait a few minutes.

**⚠WARNING** *Some Hybrid Power System service procedures present hazards that can result in severe personal injury or death. Only trained and experienced service personnel with knowledge of fuels, electricity, and machinery hazards should perform Hybrid Power System service.*

#### **FAULT NO. 314—SHORE CONTACTOR FAULT**

##### **Possible Cause**

1. Extremely low voltage due to heavy load or open breaker.
2. Defective transfer switch component.

##### **Repair Suggestion**

Verify that the shore power cord is disconnected, disconnect loads and wait a few minutes.

#### **FAULT NO. 315—SHORE CONTACTOR FAULT**

##### **Possible Cause**

1. Contactor welded shut due to high current.
2. Defective transfer switch component.

##### **Repair Suggestion**

Verify that the shore power cord is disconnected, disconnect loads and wait a few minutes.

#### **FAULT NO. 335—TRANSFER SWITCH PROCESSOR FAULT**

##### **Possible Cause**

1. Transfer Switch EE memory did not download completely.
2. Transfer Switch EE memory failed.

##### **Repair Suggestion**

Contact an authorized Cummins Onan dealer.

#### **FAULT NO. 337—INVALID SYSTEM CONFIGURATION**

##### **Possible Cause**

The system is not configured correctly.

##### **Repair Suggestion**

Contact an authorized Cummins Onan dealer.

#### **FAULT NO. 342—TRANSFER SWITCH PROCESSOR FAULT**

##### **Possible Cause**

1. Transfer Switch Program memory did not download completely.
2. Transfer Switch Program memory failed.

##### **Repair Suggestion**

Contact an authorized Cummins Onan dealer.

#### **FAULT NO. 343—TRANSFER SWITCH PROCESSOR FAULT**

##### **Possible Cause**

1. Transfer Switch Data memory did not download completely.
2. Transfer Switch Data memory failed.

##### **Repair Suggestion**

Contact an authorized Cummins Onan dealer.

**⚠WARNING** *Some Hybrid Power System service procedures present hazards that can result in severe personal injury or death. Only trained and experienced service personnel with knowledge of fuels, electricity, and machinery hazards should perform Hybrid Power System service.*

### **FAULT NO. 374—INVALID SOFTWARE**

#### **Possible Cause**

Transfer switch was shipped with functional test software.

#### **Repair Suggestion**

Contact an authorized Cummins Onan dealer.

### **FAULT NO. 381—COMMUNICATION FAULT**

#### **Possible Cause**

Loose or missing connection.

#### **Repair Suggestion**

Cycle the Hybrid Power System by disconnecting Shore Power (if connected) and turning the Coach DC Disconnect Switch to Disconnect. Wait 10 seconds and then turn it back to Connect.

### **FAULT NO. 382—COMMUNICATION FAULT**

#### **Possible Cause**

Loose or missing connection.

#### **Repair Suggestion**

Cycle the Hybrid Power System by disconnecting Shore Power (if connected) and turning the Coach DC Disconnect Switch to Disconnect. Wait 10 seconds and then turn it back to Connect.

### **FAULT NO. 383—COMMUNICATION FAULT**

#### **Possible Cause**

1. Loose or missing connection.
2. ECM is asleep.

#### **Repair Suggestion**

Cycle the Hybrid Power System by disconnecting Shore Power (if connected) and turning the Coach DC Disconnect Switch to Disconnect. Wait 10 seconds and then turn it back to Connect.

### **FAULT NO. 385—COMMUNICATION FAULT**

#### **Possible Cause**

Loose or missing connection.

#### **Repair Suggestion**

Cycle the Hybrid Power System by disconnecting Shore Power (if connected) and turning the Coach DC Disconnect Switch to Disconnect. Wait 10 seconds and then turn it back to Connect.

**⚠WARNING** *Some Hybrid Power System service procedures present hazards that can result in severe personal injury or death. Only trained and experienced service personnel with knowledge of fuels, electricity, and machinery hazards should perform Hybrid Power System service.*

### **FAULT NO. 386—COMMUNICATION FAULT**

#### **Possible Cause**

Loose or missing connection.

#### **Repair Suggestion**

Cycle the Hybrid Power System by disconnecting Shore Power (if connected) and turning the Coach DC Disconnect Switch to Disconnect. Wait 10 seconds and then turn it back to Connect.

### **FAULT NO. 387—COMMUNICATION FAULT**

#### **Possible Cause**

1. Loose or missing connection.
2. ECM is asleep.

#### **Repair Suggestion**

Cycle the Hybrid Power System by disconnecting Shore Power (if connected) and turning the Coach DC Disconnect Switch to Disconnect. Wait 10 seconds and then turn it back to Connect.

### **FAULT NO. 389—COMMUNICATION FAULT**

#### **Possible Cause**

Loose or missing connection.

#### **Repair Suggestion**

Cycle the Hybrid Power System by disconnecting Shore Power (if connected) and turning the Coach DC Disconnect Switch to Disconnect. Wait 10 seconds and then turn it back to Connect.

### **FAULT NO. 391—COMMUNICATION FAULT**

#### **Possible Cause**

Loose or missing connection.

#### **Repair Suggestion**

Cycle the Hybrid Power System by disconnecting Shore Power (if connected) and turning the Coach DC Disconnect Switch to Disconnect. Wait 10 seconds and then turn it back to Connect.

### **FAULT NO. 412—LOW OIL PRESSURE**

#### **Possible Cause**

1. Low oil level.
2. Open/loose wire connections.
3. Faulty pressure switch.
4. Engine needs service.

#### **Repair Suggestion**

Add or drain oil as necessary.

**⚠WARNING** *Some Hybrid Power System service procedures present hazards that can result in severe personal injury or death. Only trained and experienced service personnel with knowledge of fuels, electricity, and machinery hazards should perform Hybrid Power System service.*

#### **FAULT NO. 414—POWER UNIT OVER CRANK**

##### **Possible Cause**

1. Fuel supply.
2. Wiring connections.
3. Faulty starter or solenoid.
4. Faulty external start command.

##### **Repair Suggestion**

Fill up with fuel as necessary.

#### **FAULT NO. 419—GOVERNOR ACTUATOR FAULT**

##### **Possible Cause**

1. Open/loose wire connections.
2. Faulty actuator.

##### **Repair Suggestion**

Contact an authorized Cummins Onan dealer.

#### **FAULT NO. 421—GOVERNOR ACTUATOR OVERLOAD FAULT**

##### **Possible Cause**

1. Large loads.
2. Fuel supply.
3. Wire connections.
4. Actuator misadjusted.
5. Faulty actuator.
6. Water ingress.
7. Low engine performance.

##### **Repair Suggestion**

Reduce loads.

#### **FAULT NO. 424—ENGINE TEMPERATURE SENSOR FAULT**

##### **Possible Cause**

Sensor disconnected or broken.

##### **Repair Suggestion**

Contact an authorized Cummins Onan dealer.

**⚠WARNING** *Some Hybrid Power System service procedures present hazards that can result in severe personal injury or death. Only trained and experienced service personnel with knowledge of fuels, electricity, and machinery hazards should perform Hybrid Power System service.*

### **FAULT NO. 425—POWER UNIT OVER VOLTAGE**

#### **Possible Cause**

1. High engine speed under no load conditions.
2. Governor actuator is not operating correctly.

#### **Repair Suggestion**

Turn the air conditioning thermostat OFF, restart Generator Mode or connect Shore Power, and then turn the thermostat ON again. (This resets the thermostat so that it will start the air conditioners in sequence rather than all at once, greatly reducing the AC transient load on the Hybrid Power System.)

### **FAULT NO. 426—POWER UNIT UNDER VOLTAGE**

#### **Possible Cause**

1. If there was a large transient load added, the engine speed may not have been able to ramp up in time.
2. Alternator is not operating correctly.
3. Governor actuator is not operating correctly.

#### **Repair Suggestion**

Reduce loads.

### **FAULT NO. 427—PMA SENSE LOST**

#### **Possible Cause**

1. Loose/Missing wiring connections.
2. Open/shorted stator winding.
3. Faulty ECM.

#### **Repair Suggestion**

Contact an authorized Cummins Onan dealer.

### **FAULT NO. 429—HIGH BATTERY VOLTAGE**

#### **Possible Cause**

1. Batteries wired wrong.
2. Incorrect Battery type.
3. External Charger.

#### **Repair Suggestion**

1. Check battery connections.
2. Verify battery type and confirm that it is set correctly by using the Operator Panel.
3. If an external battery charger is connected, disconnect it to see whether the problem persists.

**⚠WARNING** *Some Hybrid Power System service procedures present hazards that can result in severe personal injury or death. Only trained and experienced service personnel with knowledge of fuels, electricity, and machinery hazards should perform Hybrid Power System service.*

### **FAULT NO. 431—ENGINE OVER SPEED**

#### **Possible Cause**

1. Governor actuator misadjusted.
2. Faulty actuator.
3. Speed sense leads have loose or missing connection.
4. Faulty ECM.

#### **Repair Suggestion**

Fill up with fuel as necessary.

### **FAULT NO. 432—STARTER FAULT**

#### **Possible Cause**

1. Faulty starter or starter solenoid.
2. Speed sense leads have loose or missing connections.
3. Batteries.
4. Oil viscosity.

#### **Repair Suggestion**

Contact an authorized Cummins Onan dealer.

### **FAULT NO. 434—ENGINE OVER TEMPERATURE**

#### **Possible Cause**

1. Low engine coolant.
2. Too many loads at high ambient temp or elevation.
3. Coolant pump belt.
4. Engine coolant pump.
5. Blockage to air inlet or radiator assembly due to poor installation.

#### **Repair Suggestion**

1. Check coolant level.
2. Check the cooling system for leaks.
3. Reduce loads if at high ambient temperatures or elevation.

### **FAULT NO. 435—POWER UNIT PROCESSOR FAULT**

#### **Possible Cause**

1. ECM EE memory did not download completely.
2. ECM EE memory failed.

#### **Repair Suggestion**

Contact an authorized Cummins Onan dealer.

**⚠WARNING** *Some Hybrid Power System service procedures present hazards that can result in severe personal injury or death. Only trained and experienced service personnel with knowledge of fuels, electricity, and machinery hazards should perform Hybrid Power System service.*

#### **FAULT NO. 436—ENGINE STOPPED WITHOUT COMMAND FROM CONTROL**

##### **Possible Cause**

1. Fuel supply.
2. Governor actuator misadjusted.
3. Faulty actuator.
4. Speed sense leads have loose or missing connections.
5. Wirings connections.
6. Faulty engine.

##### **Repair Suggestion**

Fill up with fuel as necessary.

#### **FAULT NO. 437—INVALID SYSTEM CONFIGURATION**

##### **Possible Cause**

The system is not configured correctly.

##### **Repair Suggestion**

Contact an authorized Cummins Onan dealer.

#### **FAULT NO. 442—POWER UNIT PROCESSOR FAULT**

##### **Possible Cause**

1. ECM Program memory did not download completely.
2. ECM EE memory failed.

##### **Repair Suggestion**

Contact an authorized Cummins Onan dealer.

#### **FAULT NO. 443—POWER UNIT PROCESSOR FAULT**

##### **Possible Cause**

1. ECM Data memory did not download completely.
2. ECM EE memory failed.

##### **Repair Suggestion**

Contact an authorized Cummins Onan dealer.

#### **FAULT NO. 459—INVERTER COOLING SYSTEM FAULT**

##### **Possible Cause**

1. Insufficient cooling (liquid not air flow).
2. Pump is not connected correctly or is faulty.

##### **Repair Suggestion**

Check the system for coolant leaks and blockages.



**⚠WARNING** *Some Hybrid Power System service procedures present hazards that can result in severe personal injury or death. Only trained and experienced service personnel with knowledge of fuels, electricity, and machinery hazards should perform Hybrid Power System service.*

#### **FAULT NO. 474—INVALID SOFTWARE**

##### **Possible Cause**

Power unit was shipped with functional test software.

##### **Repair Suggestion**

Contact an authorized Cummins Onan dealer.

#### **FAULT NO. 475—ECM FUSE FAULT (STARTER FUSE)**

##### **Possible Cause**

1. Blown starter fuse.
2. Starter or starter solenoid wiring.

##### **Repair Suggestion**

Contact an authorized Cummins Onan dealer.

#### **FAULT NO. 476—ECM FUSE FAULT (COOLANT PUMP FUSE)**

##### **Possible Cause**

1. Blown coolant pump fuse.
2. Faulty pump wiring.

##### **Repair Suggestion**

Contact an authorized Cummins Onan dealer.

#### **FAULT NO. 478—ECM FUSE FAULT (GLOW PLUG FUSE)**

##### **Possible Cause**

1. Blown glow plug fuse.
2. Glow plug wiring.

##### **Repair Suggestion**

Contact an authorized Cummins Onan dealer.

#### **FAULT NO. 479—POWER UNIT FAN WARNING**

##### **Possible Cause**

1. Open/Loose connection (3 wire).
2. Faulty fan in Power Unit.
3. Faulty ECM.

##### **Repair Suggestion**

Contact an authorized Cummins Onan dealer.

**⚠️WARNING** *Some Hybrid Power System service procedures present hazards that can result in severe personal injury or death. Only trained and experienced service personnel with knowledge of fuels, electricity, and machinery hazards should perform Hybrid Power System service.*

#### **FAULT NO. 481—COMMUNICATIONS FAULT**

##### **Possible Cause**

Loose or missing connection.

##### **Repair Suggestion**

Cycle the Hybrid Power System by disconnecting Shore Power (if connected) and turning the Coach DC Disconnect Switch to Disconnect. Wait 10 seconds and then turn it back to Connect.

#### **FAULT NO. 482—COMMUNICATIONS FAULT**

##### **Possible Cause**

Loose or missing connection.

##### **Repair Suggestion**

Cycle the Hybrid Power System by disconnecting Shore Power (if connected) and turning the Coach DC Disconnect Switch to Disconnect. Wait 10 seconds and then turn it back to Connect.

#### **FAULT NO. 484—COMMUNICATIONS FAULT**

##### **Possible Cause**

Loose or missing connection.

##### **Repair Suggestion**

Cycle the Hybrid Power System by disconnecting Shore Power (if connected) and turning the Coach DC Disconnect Switch to Disconnect. Wait 10 seconds and then turn it back to Connect.

#### **FAULT NO. 485—COMMUNICATIONS FAULT**

##### **Possible Cause**

Loose or missing connection.

##### **Repair Suggestion**

Cycle the Hybrid Power System by disconnecting Shore Power (if connected) and turning the Coach DC Disconnect Switch to Disconnect. Wait 10 seconds and then turn it back to Connect.

#### **FAULT NO. 486—COMMUNICATIONS FAULT**

##### **Possible Cause**

Loose or missing connection.

##### **Repair Suggestion**

Cycle the Hybrid Power System by disconnecting Shore Power (if connected) and turning the Coach DC Disconnect Switch to Disconnect. Wait 10 seconds and then turn it back to Connect.

**⚠WARNING** *Some Hybrid Power System service procedures present hazards that can result in severe personal injury or death. Only trained and experienced service personnel with knowledge of fuels, electricity, and machinery hazards should perform Hybrid Power System service.*

### **FAULT NO. 487—COMMUNICATIONS FAULT**

#### **Possible Cause**

1. Loose or missing connection.
2. ECM is asleep.

#### **Repair Suggestion**

Cycle the Hybrid Power System by disconnecting Shore Power (if connected) and turning the Coach DC Disconnect Switch to Disconnect. Wait 10 seconds and then turn it back to Connect.

### **FAULT NO. 489—COMMUNICATION FAULT**

#### **Possible Cause**

Loose or missing connection.

#### **Repair Suggestion**

Cycle the Hybrid Power System by disconnecting Shore Power (if connected) and turning the Coach DC Disconnect Switch to Disconnect. Wait 10 seconds and then turn it back to Connect.

### **FAULT NO. 491—COMMUNICATION FAULT**

#### **Possible Cause**

Loose or missing connection.

#### **Repair Suggestion**

Cycle the Hybrid Power System by disconnecting Shore Power (if connected) and turning the Coach DC Disconnect Switch to Disconnect. Wait 10 seconds and then turn it back to Connect.

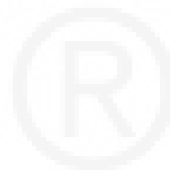

**⚠WARNING** *Some Hybrid Power System service procedures present hazards that can result in severe personal injury or death. Only trained and experienced service personnel with knowledge of fuels, electricity, and machinery hazards should perform Hybrid Power System service.*

**THIS PAGE LEFT INTENTIONALLY BLANK**

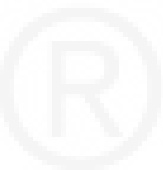

# Appendix D. Battery Interconnections

## 12 VOLT BATTERY INTERCONNECTIONS

Refer to Figure D-1 for 12 Volt Battery interconnections. Connect 12 Volt Batteries in Parallel: + to +, - to -. Battery Bank Voltage will be the same as individual battery voltage: 12 Volts. Battery Bank Capacity will be the sum of the individual battery capacities. If, for example, four 100 AHR batteries are connected in parallel, then:

$$\text{Battery Bank Capacity} = 100+100+100+100 = 400 \text{ AHRS}$$

## 6 VOLT BATTERY INTERCONNECTIONS

Refer to Figure D-1 for 6 Volt Battery interconnections. First, connect pairs of 6 Volt batteries in Series: + to -, + to -. Battery Bank Voltage will be the sum of the battery voltages: 12 Volts. (Series connections increase voltage, not AHRS.) Then, connect two or more pairs of batteries in Parallel. Battery Bank Capacity will be the sum of the battery-pair capacities. If, for example, two pairs of series-connected, 6 Volt, 200 AHR batteries are connected in parallel, then:

$$\text{Battery Bank Capacity} = 200+200 = 400 \text{ AHRS}$$

## BATTERY BANK TERMINALS

Refer to Figure D-1 for Battery Bank Terminal connections. The Battery Bank Terminals must be the diagonally opposite + and - terminals of the Battery bank. When diagonally opposite terminals are used, the total current path for each battery will be the same, that is, have the same number of inter-battery cables and terminals (resistances) in its current path. This is necessary for maximum battery bank output and uniform battery charging.

## BATTERY TEMPERATURE SENSOR

Bolt the battery temperature sensor (Figure D-1) to a centrally located positive (+) terminal for representative Battery Bank temperature sensing. The Battery Bank positive (+) terminal runs hottest because it has the highest current flow through it and is therefore not as representative of Battery Bank temperatures.

The battery temperature sensor lead connector plugs into the Inverter/Charger to provide feedback for temperature-compensated charging.

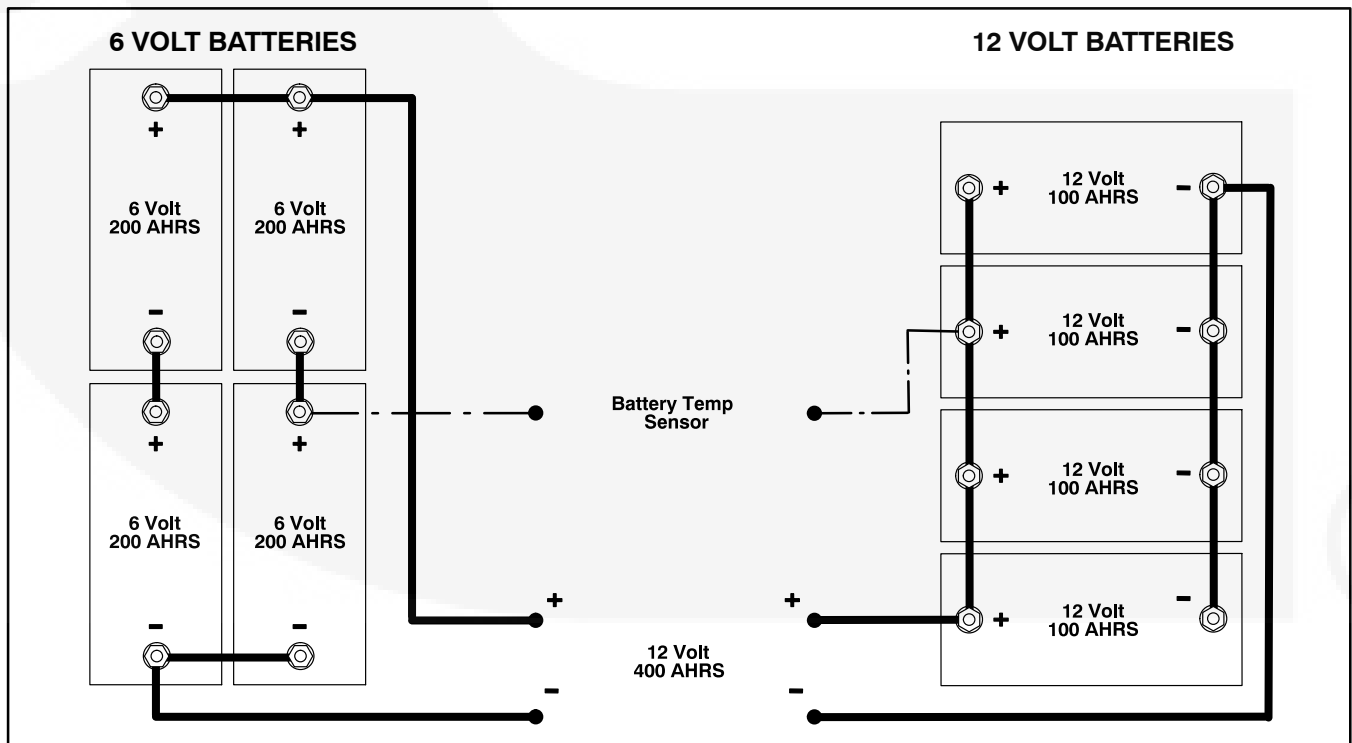

FIGURE D-1. BATTERY INTERCONNECTIONS FOR 12 VOLTS

## CONNECTING TWO INVERTER/CHARGERS

For maximum battery bank output and uniform battery charging, the two Inverter/Chargers must be connected to the Coach Batteries such that the cur-

rent flows to and from the two Inverter/Chargers are in opposite directions. That is attained by connecting the Inverter/Chargers to the battery positive (+) terminals on opposite ends of the battery bank and to the diagonally opposite battery negative (-) terminals (Figure D-2).

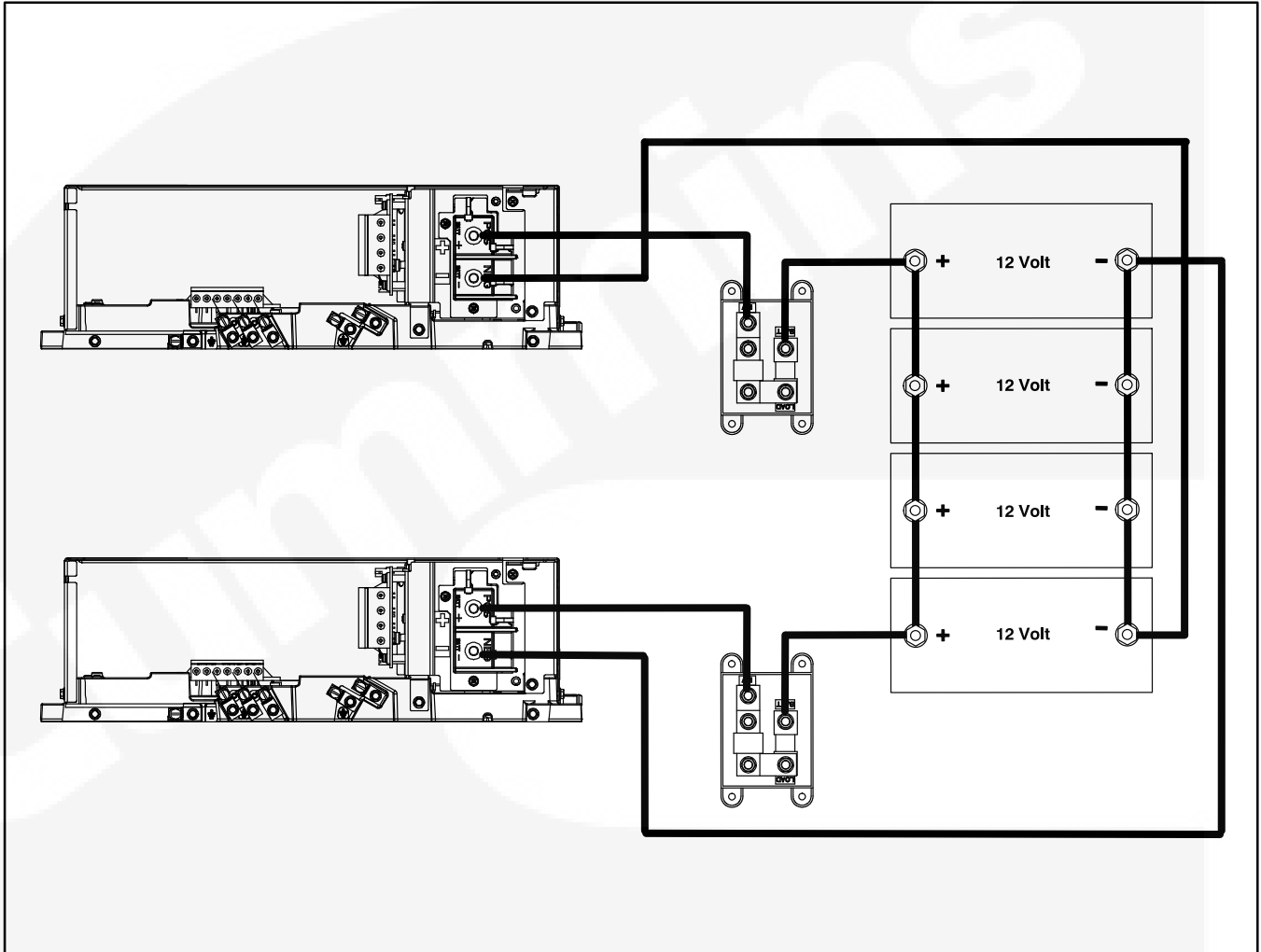

FIGURE D-2. TYPICAL CONNECTIONS WITH TWO INVERTER/CHARGERS

# Appendix E. Specifications

|  | <b>MODEL 1218 HQDSB<br/>HYBRID POWER SYSTEM</b>  | <b>MODEL 1215 HQDSB<br/>HYBRID POWER SYSTEM</b>  |
|--|--|--|
| <b>SYSTEM PERFORMANCE RATINGS</b>  |  |  |
| Operating Temperature Range  | -22°F to 122°F (-30°C to 50°C)   | -22°F to 122°F (-30°C to 50°C)   |
| Power Unit Sound @10 ft (3 m)<br>No-load<br>Half-load (6000 W)<br>Full-load  | 57 dB(A)<br>63 dB(A)<br>66 dB(A)   | 57 dB(A)<br>63 dB(A)<br>66 dB(A)   |
| Generator Mode<br>Output Voltage<br>Max Continuous AC Output @ 104°F(40°C)<br>With Battery Boost—Peak Rating<br>Air Conditioner Starting Capability  | 120/240 VAC<br>12,000 Watts<br>18,000 Watts<br>4 – 13,500 Btu ACs or<br>4 – 13,500 Btu High Efficiency ACs   | 120/240 VAC<br>12,000 Watts<br>15,000 Watts<br>3 – 13,500 Btu ACs or<br>3 – 13,500 Btu High Efficiency ACs   |
| Inverter Mode<br>Output Voltage<br>Max Continuous AC Output @ 104°F (40°C)<br>Surge Rating<br>Air Conditioner Starting Capability  | 120 VAC<br>6000 Watts<br>175%<br>1 – 13,500 Btu AC   | 120 VAC<br>3000 Watts<br>175%<br>1 – 13,500 Btu AC   |
| Shore Mode<br>Max Shore Power Service<br>Max Continuous AC Passthrough   | 50 Amps @ 120/240 VAC<br>60 Amps   | 50 Amps @ 120/240 VAC<br>30 Amps   |
| Max Battery Charging @ 14 Volts  | 280 Amps   | 140 Amps   |
| <b>SYSTEM CONTROL</b>  |  |  |
| Integrated Microprocessors—Power Unit, Inverter/Charger, Transfer Switch, Operator Panel   |  |  |
| <b>POWER UNIT</b>  |  |  |
| Maximum Continuous Power Output<br>@ 85°F (29°C)<br>@ 120°F (50°C)   | 12,000 Watts<br>11,000 Watts   | 12,000 Watts<br>11,000 Watts   |
| Alternator (Dual 3-Phase, Permanent Magnet)<br>Voltage<br>Frequency<br>Operating Speed Range   | Variable 150 to 240 Volts RMS L-L<br>Variable 186 to 346 Hz<br>1400 to 2600 RPM  | Variable 150 to 240 Volts RMS L-L<br>Variable 186 to 346 Hz<br>1400 to 2600 RPM  |
| Engine (Indirect-Injection, 4-Stroke Diesel)<br>Number of Cylinders<br>Bore<br>Stroke<br>Displacement<br>Compression Ratio<br>Oil Capacity (with filter)<br>Coolant Capacity (without Inverter/Charger)<br>Intake/Exhaust Valve Lash (Cold)<br>Fuel Nozzle Injection Pressure<br>Cylinder Compression Test | 3<br>3.07 inch (78 mm)<br>3.09 inch (78.4 mm)<br>69 inch <sup>3</sup> (1123 cc)<br>23 : 1<br>4 quart (3.8 l)<br>6.4 quart (6 l)<br>0.0065 inch (0.165 mm)<br>1991 psi (13.731 mPa)<br>370 psi (2.55 mPa) minimum | 3<br>3.07 inch (78 mm)<br>3.09 inch (78.4 mm)<br>69 inch <sup>3</sup> (1123 cc)<br>23 : 1<br>4 quart (3.8 l)<br>6.4 quart (6 l)<br>0.0065 inch (0.165 mm)<br>1991 psi (13.731 mPa)<br>370 psi (2.55 mPa) minimum |
| Engine Fuel Consumption<br>No-load<br>Half-load (6000 W)<br>Full-load  | 0.50 gph (1.89 l/h)<br>0.87 gph (3.29 l/h)<br>1.33 gph (5.03 l/h)  | 0.50 gph (1.89 l/h)<br>0.87 gph (3.29 l/h)<br>1.33 gph (5.03 l/h)  |
| Engine Cranking Current  | 280 amps   | 280 amps   |

|  | <b>MODEL 1218 HQDSB<br/>HYBRID POWER SYSTEM</b>                          | <b>MODEL 1215 HQDSB<br/>HYBRID POWER SYSTEM</b>                          |
|--|--|--|
| <b>AUTOMATIC TRANSFER SWITCH (ATS)</b>                               |  |  |
| Max Input from Shore Power Service                                   | 15 to 30 Amps @ 120 VAC or,<br>50 Amps @ 120/240 VAC                     | 15 to 30 Amps @ 120 VAC or,<br>50 Amps @ 120/240 VAC                     |
| Max Input from Hybrid Power System                                   | 75 Amps @ 120/240 VAC  | 62.5 Amps @ 120/240 VAC  |
| Shore Quality Monitoring   | Connects when Conditions Met, Dis-<br>connects when Not Met              | Connects when Conditions Met, Dis-<br>connects when Not Met              |
| Voltage Range  | 95 to 132 L-N  | 95 to 132 L-N  |
| Frequency Range  | 54 to 70 Hz  | 54 to 70 Hz  |
| Under Voltage Disconnect Time  | 8 seconds  | 8 seconds  |
| High Voltage (132 Vrms) Disconnect Time                              | 1 second   | 1 second   |
| Over Voltage (140 Vrms) Disconnect Time                              | 0.1 seconds  | 0.1 seconds  |
| Over/Under Frequency Disconnect Time                                 | 30 seconds   | 30 seconds   |
| Loss of Neutral Disconnect Time                                      | 0.5 seconds  | 0.5 seconds  |
| Reverse Connection Disconnect Time                                   | 0.5 seconds  | 0.5 seconds  |
| Shore Connection Time  | 3 seconds  | 3 seconds  |
| Contactor Voltage Rating   | 120 VAC  | 120 VAC  |
| Drop Out Voltage   | 70 VAC   | 70 VAC   |
| Surge Suppression  | 1050 Joules  | 1050 Joules  |
| Shore Fuse Type  | 60A RK1 or K5  | 60A RK1 or K5  |
| Shore to HQD Transition Time   | 30 seconds   | 30 seconds   |
| <b>INVERTER/CHARGERS (Two Required)</b>                              |  |  |
| Output Voltage (60 Hz, Sine)   | 120 VAC +/- 3%   | 120 VAC +/- 3%   |
| Recommended Class T DC Fuse Rating                                   | 400 Amps   | 400 Amps   |
| Maximum Cable Length   | 10 ft  | 10 ft  |
| Minimum Cable Size   | 4/O  | 4/O  |
| Voltage Band Width   | +/- 0.5%   | +/- 0.5%   |
| Output Frequency   | 60 Hz +/- 0.5%   | 60 Hz +/- 0.5%   |
| Output Frequency Variation   | +/- 0.1%   | +/- 0.1%   |
| Output Waveform  | Sine < 5% THD  | Sine < 5% THD  |
| Full Load Efficiency @ 77°F (25°C), 12 VDC                           | 82%  | 82%  |
| Maximum Charging Current @ 14 VDC                                    | 140 Amps (each Inverter/Charger)   | 140 Amps (Model HDQVA only)  |
| Shore Power Power Factor when Charging                               | > 0.98   | > 0.98   |
| Shunt (Two Required)   | High Side 50 mv, 500 amps  | High Side 50 mv, 500 amps  |
| Coolant Capacity (Heat Exchanger and hoses)                          | Approximately 2 gallons (4 liters)                                       | Approximately 2 gallons (4 liters)                                       |
| <b>COACH BATTERY REQUIREMENTS</b>                                    |  |  |
| Battery Types Supported  | Wet Cell, Gel, AGM   | Wet Cell, Gel, AGM   |
| Nominal Voltage  | 12 VDC   | 12 VDC   |
| Minimum Coach Battery Bank Capacity                                  | 600 Amp Hours  | 600 Amp Hours  |
| <b>WEIGHTS AND DIMENSIONS</b>  |  |  |
| Power Unit<br>Weight (wet)<br>Length x Width x Height                | 485 lbs (220 kg)<br>41.1 x 24.1 x 27 inch<br>(1043.9 x 612.1 x 685.8 mm) | 485 lbs (220 kg)<br>41.1 x 24.1 x 27 inch<br>(1043.9 x 612.1 x 685.8 mm) |
| Inverter/Charger (Two Required)<br>Weight<br>Length x Width x Height | 56.7 lbs (25.7 kg)<br>21.1 x 13.39 x 6.4 inch<br>(536 x 340 x 63 mm)     | 56.7 lbs (25.7 kg)<br>21.1 x 13.39 x 6.4 inch<br>(536 x 340 x 63 mm)     |
| Transfer Switch<br>Weight<br>Length x Width x Height                 | 13 lbs (5.6 kg)<br>11.97 x 10.94 x 4.33 inch<br>(304 x 278 x 110 mm)     | 13 lbs (5.6 kg)<br>11.97 x 10.94 x 4.33 inch<br>(304 x 278 x 110 mm)     |



| Fault Code | Inv Display Code | Flash Code | Type    | Message Text Line 1 | Message Text Line 2 | Description   | Service File Name                | Modes that are disabled  | What works?  |
|------------|------------------|------------|---------|---------------------|---------------------|---|----------------------------------|--|--|
|            |                  |            | Info    | AGS Expired         |                     | Safety input has not been activated in 30 days or battery has been disconnected | AGS Expired                      |  |  |
|            |                  |            | Info    | AGS                 | Will Expire         | AGS timer will in expire in 1-5 days  |                                  |  |  |
|            | 0                | 0          |         |                     |                     |   |                                  |  |  |
| 101        | 201              |            | Warning | Very Low            | Battery             |   |                                  |  |  |
| 102        | 202              |            | Warning | Low Battery         | Cut Out             | Battery voltage too low for proper inverter operation                           |                                  |  |  |
| 112/212    | 212              | 12         | Fault   | High AC             | Voltage             | High inverter output voltage  | AC Output Over Voltage           | PU and inverter/charger disabled<br>Battery charging may/maynot be available depending on intermittent/hard failure<br>PU, Inverter/Charger modes disabled | Shore Pass through only.<br>Manage battery usage   |
| 113/213    | 213              | 13         | Fault   | Low AC              | Voltage             | Low inverter output voltage   | AC Output Under Voltage          | PU and inverter/charger disabled<br>Battery charging may/maynot be available depending on intermittent/hard failure<br>PU, Inverter/Charger modes disabled | Shore Pass through only.<br>Manage battery usage   |
| 114/214    | 214              | 14         | Fault   | Inverter Fault      | See Manual          | Primary and secondary inverter outputs are out of sync                          |                                  | PU and inverter/charger disabled   | Applicable only to 12/18 units.<br>Shore pass through only. Battery Charging available   |
| 115/215    | 215              | 15         | Fault   | Inverter Fault      | See Manual          | Primary Inverter detects secondary inverter has faulted                         |                                  | PU and inverter/charger disabled   | Either Primary/Secondary inverter detected that the other faulted.<br>Power availability will depend on what the exact fault code is |
| 116/216    | 216              | 16         | Fault   | High Inverter       | Temperature         | High boost component temperature  | Boost Over Temperature           | PU, Inverter/Charger modes disabled  | Shore pass through available   |
| 117/217    | 217              | 17         | Fault   | High Charger        | Temperature         | High charger component temperature  | Charger Over Temperature         | PU, Inverter/Charger modes disabled  | Shore pass through available   |
| 118/218    | 218              | 18         | Fault   | High Inverter       | Temperature         | High inverter component temperature   | Inverter Over Temperature        | PU, Inverter/Charger modes disabled  | Shore pass through available   |
| 119/219    | 219              | 19         | Fault   | Inverter            | Overload            | Very high inverter output current or inverter output short circuit              | AC Output Short Circuit          | PU and inverter/charger disabled<br>If hard failure, no battery charging<br>If intermittent problem, normal operation available                            | Shore pass through only  |
| 124/224    | 224              | 24         | Fault   | Battery Temp        | Sensor Fault        | Battery temperature sensor out of range   | Battery Temperature Sensor Fault | PU, Inverter/Charger modes disabled  | Shore pass through only<br>Manage battery usage  |

| Fault Code | Inv Display Code | Flash Code | Type  | Message Text Line 1 | Message Text Line 2 | Description  | Service File Name                 | Modes that are disabled             | What works?   |
|------------|------------------|------------|-------|---------------------|---------------------|--|-----------------------------------|-------------------------------------|---|
| 125/225    | 225              | 25         | Fault | Inverter Fault      | See Manual          | DC bus over 450vdc for greater than 100 microseconds     | High DC bus voltage               | PU/Inver/Charger disabled.          | If fault occurs in PU mode, system will operate in Inverter, Shore and Charger mode<br>If fault occurs in Inverter mode, Shore mode & Charger will work                                 |
| 126/226    | 226              | 26         | Fault | Inverter Temp       | Sensor Fault        | Boost component temperature sensor out of range          | Boost Temperature Sensor Fault    | PU, Inverter/Charger modes disabled | Shore pass-through only. Manage battery usage.  |
| 127/227    | 227              | 27         | Fault | Inverter Temp       | Sensor Fault        | Charger component temperature sensor out of range        | Charger Temperature Sensor Fault  | PU, Inverter/Charger modes disabled | Shore pass-through only. Manage battery usage.  |
| 128/228    | 228              | 28         | Fault | Inverter Temp       | Sensor Fault        | Inverter component temperature sensor out of range       | Inverter Temperature Sensor Fault | PU, Inverter/Charger modes disabled | Shore pass-through only. Manage battery usage.  |
| 129/229    | 229              | 29         | Fault | High Battery        | Voltage             | High battery voltage detected by inverter                | High Battery Voltage              | PU, Inverter/Charger modes disabled | Shore pass-through only. Manage battery usage.  |
| 131/231    | 231              | 31         | Fault | High Inverter       | Temperature         | High inverter inductor temperature                       | Inverter Over Temperature         | PU and inverter/charger disabled    | All modes will work if loads on the system are reduced or increase air flow to the inverter   |
| 132/232    | 232              | 32         | Fault | Inverter Temp       | Sensor Fault        | Inverter output inductor temperature sensor out of range | Inverter Temperature Sensor Fault | PU, Inverter/Charger modes disabled | Shore pass-through only. Manage battery usage.  |
| 134/234    | 234              | 34         | Fault | High Battery        | Current             | High boost current detected by boost detection circuit   | Boost Over Current Fault          | PU, Inverter/Charger modes disabled | Shore pass-through only. Manage battery usage<br>Charge batteries using external charger or chassis engine.<br>Reduce large transient loads on the system to avoid engaging boost mode. |
| 135/235    | 235              | 35         | Fault | Inverter            | Control Fault       | Error in inverter processor EEPROM memory                | Inverter Processor Fault          | PU, Inverter/Charger modes disabled | Shore pass-through only. Manage battery usage.  |
| 136/236    | 236              | 36         | Fault | Alternator          | Under Voltage       | Alternator voltage low                                   | Low DC Bus Voltage Fault          | PU, Inverter/Charger modes disabled | If symptom was caused in PU mode; Shore power, Battery mode & Charger will be available. (If critical AC load is required, disable Charger temporarily)                                 |

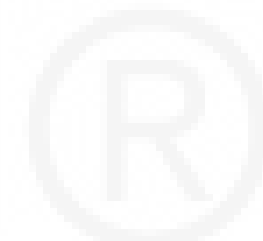

| Fault Code | Inv Display Code | Flash Code | Type  | Message Text Line 1 | Message Text Line 2 | Description   | Service File Name             | Modes that are disabled             | What works?   |
|------------|------------------|------------|-------|---------------------|---------------------|---|-------------------------------|-------------------------------------|---|
| 138/238    | 238              | 38         | Fault | Inverter            | Overload            | High inverter output current  | High AC Current               | Inverter/Charger disabled           | This is normally caused by large loads with high inrush. Reduce loads. Shore mode, PU modes will work.  |
| 139/239    | 239              | 39         | Fault | Low Battery         | Voltage             | Low battery voltage detected by power unit                                  | Low Battery Voltage           | Inverter/Charger disabled           | Low battery has been detected. Connect either to Shore or PU to charge batteries. Avoid large load steps until batteries are fully charged. Shore Mode, PU & Inverter mode will work. Manage battery charging |
| 141/241    | 241              | 41         | Fault | Power Unit          | Breaker Open        | Power unit running and inverter does not detect power. Circuit breaker open | Power Unit Breaker Open       | Inverter/Charger disabled           | Check if breaker is closed. Shore & Inverter mode available   |
| 142/242    | 242              | 42         | Fault | Inverter            | Control Fault       | Error in inverter processor program memory                                  | Inverter Processor Fault      | PU, Inverter/Charger modes disabled | Shore pass-through only. Manage battery usage   |
| 143/243    | 243              | 43         | Fault | Inverter            | Control Fault       | Error in inverter processor data memory                                     | Inverter Processor Fault      | PU, Inverter/Charger modes disabled | Shore pass-through only. Manage battery usage   |
| 145/245    | 245              | 45         | Fault | Inverter Fault      | See Manual          | DC bus voltage not detected.  | Loss of DC Bus Voltage        | PU, Inverter/Charger modes disabled | Shore pass-through only. Manage battery usage   |
| 146/246    | 246              | 46         | Fault | Inverter Fault      | See Manual          | The inverter power supply is operating out of specification                 | Power Supply Fault            | PU, Inverter/Charger modes disabled | Shore pass-through only. Manage battery usage   |
| 147        | 247              | 47         | Fault | DC current          | Sensor Fault        | Inverter current sensor out of range.                                       | Inverter Current Sensor Fault | PU, Inverter/Charger modes disabled |   |
| 148/248    | 248              | 48         | Fault | AC current          | Sensor Fault        | Inverter current sensor out of range.                                       | Inverter Current Sensor Fault | PU, Inverter/Charger modes disabled | Shore pass-through only. Manage battery usage. This fault occurs only in PU & Inverter modes  |
| 149        | 249              | 49         | Fault | Inverter Fault      | See Manual          | Shore breakers tripped  | na                            |                                     |   |
| 151/251    | 251              | 51         | Fault | Inverter            | Control Fault       | Error in processor analog detection function                                | Inverter Processor Fault      | PU, Inverter/Charger modes disabled | Shore pass-through only. Manage battery usage   |
| 152        | 252              | 52         | Fault | AC voltage          | Sensor Fault        | Inverter AC voltage sensor not detecting voltage                            | na                            | PU, Inverter/Charger modes disabled | Shore pass-through only. Manage battery usage   |
| 153        | 253              | 53         | Fault | Current             | Sensor Fault        | Boost current reading is invalid  | na                            | PU, Inverter/Charger modes disabled | Shore pass-through only. Manage battery usage   |
| 154        | 254              | 54         | Fault | Battery             | Sensor Fault        | Battery current reading is invalid  | na                            | PU, Inverter/Charger modes disabled | Shore pass-through only. Manage battery usage   |

| Fault Code | Inv Display Code | Flash Code | Type    | Message Text Line 1 | Message Text Line 2 | Description                                   | Service File Name                  | Modes that are disabled   | What works?   |
|------------|------------------|------------|---------|---------------------|---------------------|---|------------------------------------|---|---|
| 156/256    | 256              | 56         | Fault   | Inverter Temp       | Sensor fault        | Cold Plate Temperature out of Range           | Inverter Temperature Sensor Fault  | PU, Inverter/Charger modes disabled   | Shore pass-through only.<br>Manage battery usage  |
| 157/257    | 257              | 57         | Fault   | High Inverter       | Temperature         | High Inverter Ambient temperature             | Boost Over Temperature             |   | Shore, PU & Inverter modes will work<br>Increase air flow to inverter. Remove any blockages obstructing air flow                                  |
| 158/258    | 258              | 58         | Warning | High Battery        | Temperature         | High battery temperature                      | High Battery Temperature           | Warning only, nothing disabled.   | All modes will work.<br>Just warning not a fault  |
| 162/262    | 262              | 62         | Warning | Inverter Fan        | Failure             | Inverter fan speed not detected               | Inverter Fan Fault                 | Warning only.   | Warning only – All modes will work with low loads. May experience intermittent overtemp shutdowns. Increase of cooling air to inverter will help. |
| 163/263    | 263              | 63         | Fault   | High Inverter       | Temperature         | High boost transformer temperature            | Boost Over Temperature             | PU, Inverter/Charger modes disabled   | Shore pass through only   |
| 164/264    | 264              | 64         | Fault   | Inverter Temp       | Sensor Fault        | Boost transformer temperature is out of range | Boost Temperature Sensor Fault     | PU, Inverter/Charger modes disabled   | Shore pass through only<br>Manage battery usage   |
| 165/265    | 265              | 65         | Fault   | Inverter Fault      | See Manual          | Very high boost or charger current detected.  | Boost / Charger Over Current Fault | PU, Inverter/Charger modes disabled   | Shore pass-through only   |
| 168/268    | 268              | 68         | Fault   | Software Versi      | Incompatible        | Software Versions are not compatible          | Software Version Fault             | System disabled due to incompatible software calibration. Contact your nearest Cummins Onan Distributor to get the latest calibration |   |
| 171/271    | 271              | 71         | Fault   | Boost               | Overload            | High battery current                          | Boost Over Current                 | PU mode disabled due to high current. If loads are kept low, fault will not occur.<br>Battery Charging available through Shore power  | Shore & Inverter mode<br>Shore to<br>and/or   |
| 172/272    | 272              | 72         | Fault   | Inverter            | Test Fault          | Inverter in Test Mode                         | Invalid Software                   | System disabled<br>This should not happen until settings changed during install or service  |   |
| 173/273    | 273              | 73         | Fault   | Charger             | Overload            | Shorted charger output                        | Charger Output Short Circuit       | Charger disabled, shore/PU power pass-through enabled. (AC continues to be available to the coach)<br>Inverter mode not available     | Shore and PU power pass-through is available.Charger is disabled  |
| 174/274    | 274              | 74         | Fault   | Inverter Fault      | See Manual          | Low DC bus voltage when entering battery mode | Boost Fault                        | Battery Mode disabled. Shore charge and PU mode will continue to work (with exceptions)<br>Inverter mode not available                | Shore and PU power pass-through is available.Charger is disabled  |

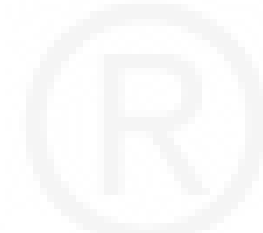

|         |     |    |         |                |                |  |                      |  |  |
|---------|-----|----|---------|----------------|----------------|--|----------------------|--|--|
| 175/275 | 275 | 75 | Fault   | Inverter Fault | See Manual     | Factory test fault Inverter not programmed properly                          | Invalid Software     | System disabled<br>This should not happen until settings changed during install or service |  |
| 176/276 | 276 | 76 | Fault   | Charger Fault  | Breaker Open   | Inverter input breaker is open   | Charger Fault        | Intermittent fault on power-up in shore mode   | If fault is intermittent, the breaker in the distribution panel that feeds the charger is likely open. Inspect and reset if needed. If hard failure, unit can be brought in for service, power up system in charger mode first then plug in shore power – then no fault. |
| 181/281 | 281 | 81 | Fault   | Comm fault     | Inverter Prime | Primary inverter is not receiving CAN communications from secondary inverter | Communications Fault | PU, Inverter/Charger modes disabled  | Shore pass-through only. Manage battery usage.   |
| 182/282 | 282 | 82 | Fault   | Comm fault     | Inverter Sec   | Secondary inverter is not receiving CAN communications from primary inverter | Communications Fault | PU, Inverter/Charger modes disabled  | Shore pass-through only. Manage battery usage.   |
| 183/283 | 283 | 83 | Fault   | Comm fault     | Power Unit     | Power unit is not receiving CAN communications                               | Communications Fault | PU, Inverter/Charger modes disabled  | Shore pass-through only. Manage battery usage.   |
| 184/284 | 284 | 84 | Fault   | Comm fault     | Transfer Sw    | Transfer switch is not receiving CAN communications                          | Communications Fault | PU, Inverter/Charger modes disabled  | Shore pass-through only. Manage battery usage.   |
| 185/285 | 285 | 85 | Fault   | Comm fault     | Inverter       | Inverter is not sending CAN communications                                   | Communications Fault | PU, Inverter/Charger modes disabled  | Shore pass-through only. Manage battery usage.   |
| 186/286 | 286 | 86 | Fault   | Comm fault     | Inverter Sec   | Secondary inverter is not sending CAN messages                               | Communications Fault | PU, Inverter/Charger modes disabled  | Shore pass-through only. Manage battery usage.   |
| 187/287 | 287 | 87 | Fault   | Comm fault     | Power Unit     | Power unit is not sending CAN messages                                       | Communications Fault | PU, Inverter/Charger modes disabled  | Shore pass-through only. Manage battery usage.   |
| 189/289 | 289 | 89 | Fault   | Comm fault     | Transfer Sw    | Transfer switch is not sending CAN messages                                  | Communications Fault | PU, Inverter/Charger modes disabled  | Shore pass-through only. Manage battery usage.   |
| 191/291 | 291 | 91 | Fault   | Comm fault     | Inverter       | Inverter is not receiving CAN communications                                 | Communications Fault | PU, Inverter/Charger modes disabled  | Shore pass-through only. Manage battery usage.   |
| 201     | 201 |    | Warning | Very Low       | Battery        |  |                      |  |  |
| 302     |     |    | Warning | AGS Safety     | Input Detected | AGS safety input has been activated  |                      |  |  |

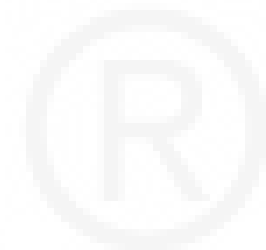

| Fault Code | Inv Display Code | Flash Code | Type    | Message Text Line 1 | Message Text Line 2 | Description   | Service File Name               | Modes that are disabled   | What works?   |
|------------|------------------|------------|---------|---------------------|---------------------|---|---------------------------------|---|---|
| 312        |                  | 12         | Warning | Transfer Sw         | Not Closed          | Power Unit contact in Transfer Switch did not close         | Power Unit Contactor Fault      | PU mode disabled. This is a warning. PU mode disabled (if contactor failed to close), shore pass-through still possible, battery mode still possible. When in shore mode only inverter loads will be powered. | Warning only<br>Shore mode & Battery mode available. Note only inverter loads will be powered in Shore mode |
| 313        |                  | 13         | Fault   | Transfer Sw         | Fault               | Power Unit contact in Transfer Switch did not open          | Power Unit Contactor Fault      | Shore mode disabled   | PU, Inverter/Charger mode available   |
| 314        |                  | 14         | Warning | Transfer Sw         | Not Closed          | Shore power contactor in Transfer Switch did not close      | Shore Contactor Fault           | Shore mode disabled   | PU, Charger mode available  |
| 315        |                  | 15         | Fault   | Transfer Sw         | Fault               | Shore power contactor in Transfer Switch did not open       | Shore Contactor Fault           |   | Shore pass through only. Manage battery usage   |
| 318        |                  | 18         | Warning | Comm fault          | Transfer Sw         | Transfer switch is not receiving communication from display | Communications Fault            |   |   |
| 319        |                  | 19         | Fault   | Transfer Sw         | Sensor Fault        | Auxiliary switch for the Shore contactor has failed         |                                 |   |   |
| 321        |                  | 21         | Fault   | Transfer Sw         | Sensor Fault        | Auxiliary switch for the Power Unit contactor has failed    |                                 |   |   |
| 335        |                  | 35         | Fault   | Transfer Sw         | Control Fault       | Error in transfer switch processor EEPROM memory            | Transfer Switch Processor Fault | PU, Inverter/Charger modes disabled   | Shore mode available  |
| 337        |                  | 37         | Fault   | Invalid System      | Configuration       | Invalid System Configuration                                | Na                              | System disabled<br>Contact nearest Cummins Onan Distributor for support   |   |
| 342        |                  | 42         | Fault   | Transfer Sw         | Control Fault       | Error in transfer switch processor program memory           | Transfer Switch Processor Fault | PU, Inverter/Charger modes disabled   | Shore mode available  |
| 343        |                  | 43         | Fault   | Transfer Sw         | Control Fault       | Error in transfer switch processor data memory              | Transfer Switch Processor Fault | PU, Inverter/Charger modes disabled   | Shore mode available  |
| 351        |                  | 51         | Fault   | Control Card        | Failure - A/D       | Error in processor analog detection function                |                                 |   |   |
| 368        |                  | 68         | Fault   | S/W Version         | Incompatible        | Software Versions are not compatible                        | Software Version Fault          | System disabled due to incompatible software calibration. Contact your nearest Cummins Onan Distributor to get the latest calibration   |   |
| 372        |                  | 72         | Fault   | Transfer Sw         | Test Fault          | Transfer Switch in Test mode                                | Invalid Software                | System disabled<br>Contact nearest Cummins Onan Distributor for support   |   |
| 381        |                  | 81         | Fault   | Comm fault          | Inverter            | Inverter is not receiving CAN communications                | Communications Fault            | PU, Inverter/Charger modes disabled   | Shore pass through only. Manage battery usage   |
| 382        |                  | 82         | Fault   | Comm fault          | Inverter Sec        | Secondary inverter is not receiving CAN communications      | Communications Fault            | PU, Inverter/Charger modes disabled   | Shore pass through only. Manage battery usage   |

| Fault Code | Inv Display Code | Flash Code | Type  | Message Text Line 1 | Message Text Line 2 | Description   | Service File Name               | Modes that are disabled             | What works?  |
|------------|------------------|------------|-------|---------------------|---------------------|---|---------------------------------|-------------------------------------|--|
| 383        |                  | 83         | Fault | Comm fault          | Power unit          | Power unit is not receiving CAN communications      | Communications Fault            | PU, Inverter/Charger modes disabled | Shore pass through only. Manage battery usage                        |
| 385        |                  | 85         | Fault | Comm fault          | Inverter            | Inverter is not sending CAN communications          | Communications Fault            | PU, Inverter/Charger modes disabled | Shore pass through only. Manage battery usage                        |
| 386        |                  | 86         | Fault | Comm fault          | Inverter Sec        | Secondary inverter is not sending CAN messages      | Communications Fault            | PU, Inverter/Charger modes disabled | Shore pass through only. Manage battery usage                        |
| 387        |                  | 87         | Fault | Comm fault          | Power unit          | Power unit is not sending CAN messages              | Communications Fault            | PU, Inverter/Charger modes disabled | Shore pass through only. Manage battery usage                        |
| 389        |                  | 89         | Fault | Comm fault          | Transfer Sw         | Transfer switch is not sending CAN messages         | Communications Fault            | PU, Inverter/Charger modes disabled | Shore pass through only. Manage battery usage                        |
| 391        |                  | 91         | Fault | Comm fault          | Transfer Sw         | Transfer switch is not receiving CAN communications | Communications Fault            | PU, Inverter/Charger modes disabled | Shore pass through only. Manage battery usage                        |
| 412        |                  | 12         | Fault | Low Oil             | Pressure            | Power unit engine low oil pressure                  | Low Oil Pressure                | PU mode disabled                    | Shore pass through & inverter/charger mode available                 |
| 414        |                  | 14         | Fault | Overcrank           |                     | Power unit over crank                               | Power Unit Over Crank           | PU mode disabled                    | Shore pass through & inverter/charger mode available                 |
| 419        |                  | 19         | Fault | Governor Short      | or Open             | Governor actuator circuit open or shorted.          | Governor Actuator Fault         | PU mode disabled                    | Shore pass through & inverter/charger mode available                 |
| 421        |                  | 21         | Fault | Governor            | Overload            | Engine overload                                     | Governor Actuator Overload      | PU mode disabled                    | Shore pass through & inverter/charger mode available<br>Reduce loads |
| 424        |                  | 24         | Fault | Faulty Engine       | Temp Sender         | Power unit engine temperature sensor out of range   | Engine Temperature Sensor Fault | PU mode disabled                    | Shore pass through & inverter/charger mode available                 |
| 425        |                  | 25         | Fault | Alternator          | Over Voltage        | High power unit output voltage                      | Power Unit Over Voltage         | PU mode disabled                    | Shore pass through & inverter/charger mode available                 |
| 426        |                  | 26         | Fault | Alternator          | Under Voltage       | Low power unit output voltage                       | Power Unit Under Voltage        | PU mode disabled                    | Shore pass through & inverter/charger mode available                 |
| 427        |                  | 27         | Fault | Engine Speed        | Sensor Fault        | Power unit control is not detecting engine speed    | PMA sense lost                  | PU mode disabled                    | Shore pass through & inverter/charger mode available                 |
| 429        |                  | 29         | Fault | High Battery        | Voltage             | High battery voltage detected by power unit         | High Battery Voltage            | PU, Inverter/Charger modes disabled | Shore pass through available   |
| 431        |                  | 31         | Fault | High Engine         | Speed               | High engine speed                                   | Engine Over Speed               | PU mode disabled                    | Shore pass through & inverter/charger mode available                 |

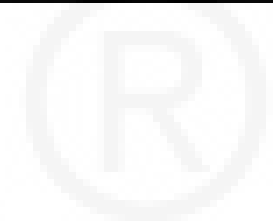

| Fault Code | Inv Display Code | Flash Code | Type  | Message Text Line 1 | Message Text Line 2 | Description   | Service File Name             | Modes that are disabled   | What works?  |
|------------|------------------|------------|-------|---------------------|---------------------|---|-------------------------------|---|--|
| 432        |                  | 32         | Fault | Starting Fault      |                     | Engine speed not detected when starter engaged                      | Starter Fault                 | PU mode disabled  | Shore pass through & inverter/charger mode available |
| 434        |                  | 34         | Fault | High Engine         | Temperature         | High power unit engine coolant temperature                          | Engine Over Temperature       | PU mode disabled  | Shore pass through & inverter/charger mode available |
| 435        |                  | 35         | Fault | Power unit          | Control Fault       | Error in power unit processor EEPROM memory                         | Power Unit Processor Fault    | PU mode disabled  | Shore pass through & inverter/charger mode available |
| 436        |                  | 36         | Fault | Gen Stop            | Check Fuel          | Power unit engine stopped for unknown reason                        | Engine Stopped                | PU mode disabled  | Shore pass through & inverter/charger mode available |
| 437        |                  | 37         | Fault | Invalid System      | Configuration       | Invalid System Configuration  | Na                            | System disabled<br>Contact nearest Cummins Onan Distributor for support   |  |
| 442        |                  | 42         | Fault | Power unit          | Control Fault       | Error in power unit processor program memory                        | Power Unit Processor Fault    | PU mode disabled  | Shore pass through & inverter/charger mode available |
| 443        |                  | 43         | Fault | Power unit          | Control Fault       | Error in power unit processor data memory                           | Power Unit Processor Fault    | PU mode disabled  | Shore pass through & inverter/charger mode available |
| 451        |                  | 51         | Fault | Control Card        | Failure - A/D       | Error in processor analog detection function                        |                               | PU mode disabled  | Shore pass through & inverter/charger mode available |
| 459        |                  | 59         | Fault | Check               | Coolant             | High inverter coolant temperature or failure in coolant circulation | Inverter Coolant System Fault | PU mode disabled  | Shore pass through & inverter/charger mode available |
| 468        |                  | 68         | Fault | S/W Version         | Incompatible        | Software Versions are not compatible                                | Software Version Fault        | System disabled due to incompatible software calibration. Contact your nearest Cummins Onan Distributor to get the latest calibration |  |
| 473        |                  | 73         | Fault | Power Unit          | Fail to Start       | Power Unit failed to start in                                       |                               |   |  |
| 474        |                  | 74         | Fault | Power Unit          | Test Fault          | Power Unit in Test mode   | Invalid Software              | System disabled<br>Contact nearest Cummins Onan Distributor for support   |  |
| 475        |                  | 75         | Fault | Power Unit          | Starter Fuse        | Power Unit Starter Fuse blown                                       | ECM Fuse Fault                | PU mode disabled  | Shore pass through & inverter/charger mode available |
| 476        |                  | 76         | Fault | Power Unit          | Coolant Fuse        | Power Unit Coolant Pump Fuse blown                                  | ECM Fuse Fault                | PU mode disabled  | Shore pass through & inverter/charger mode available |



| Fault Code | Inv Display Code | Flash Code | Type    | Message Text Line 1 | Message Text Line 2 | Description  | Service File Name      | Modes that are disabled             | What works?   |
|------------|------------------|------------|---------|---------------------|---------------------|--|------------------------|-------------------------------------|---|
| 478        |                  | 78         | Fault   | Power Unit          | Glow Plug Fuse      | Power Unit Glow Plug Fuse blown                        | ECM Fuse Fault         | PU mode disabled                    | Shore pass through & inverter/charger mode available      |
| 479        |                  | 79         | Warning | Power Unit          | Fan Fault           | Power Unit Fan Warning                                 | Power Unit Fan Warning |                                     | Warning only<br>System will operate normally in all modes |
| 481        |                  | 81         | Fault   | Comm fault          | Inverter            | Inverter is not receiving CAN communications           | Communications Fault   | PU, Inverter/Charger modes disabled | Shore pass through only. Manage battery usage             |
| 482        |                  | 82         | Fault   | Comm fault          | Inverter Sec        | Secondary inverter is not receiving CAN communications | Communications Fault   | PU, Inverter/Charger modes disabled | Shore pass through only. Manage battery usage             |
| 484        |                  | 84         | Fault   | Comm fault          | Transfer Sw         | Transfer switch in not receiving CAN messages          | Communications Fault   | PU, Inverter/Charger modes disabled | Shore pass through only. Manage battery usage             |
| 485        |                  | 85         | Fault   | Comm fault          | Inverter            | Inverter is not sending CAN communications             | Communications Fault   | PU, Inverter/Charger modes disabled | Shore pass through only. Manage battery usage             |
| 486        |                  | 86         | Fault   | Comm fault          | Inverter Sec        | Secondary inverter is not sending CAN messages         | Communications Fault   | PU, Inverter/Charger modes disabled | Shore pass through only. Manage battery usage             |
| 487        |                  | 87         | Fault   | Comm fault          | Power Unit          | Power unit is not sending CAN messages                 | Communications Fault   | PU, Inverter/Charger modes disabled | Shore pass through only. Manage battery usage             |
| 489        |                  | 89         | Fault   | Comm fault          | Transfer Sw         | Transfer switch is not sending CAN messages            | Communications Fault   | PU, Inverter/Charger modes disabled | Shore pass through only. Manage battery usage             |
| 491        |                  | 91         | Fault   | Comm fault          | Power Unit          | Power unit is not receiving CAN communications         | Communications Fault   | PU, Inverter/Charger modes disabled | Shore pass through only. Manage battery usage             |

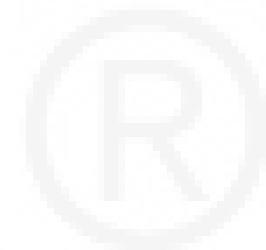



# Cummins **Onan**

## **Cummins Power Generation**

1400 73rd Ave. NE  
Minneapolis, MN 55432 USA

Phone 1 763 574 5000

Toll-free 1 800 888 6626

Fax 1 763 574 5298

Email [www.cumminsonan.com/contact](http://www.cumminsonan.com/contact)

[www.cumminsonan.com](http://www.cumminsonan.com)

Cummins®, Onan®, the "C" logo, and "Performance you rely on." are trademarks of Cummins Inc.

©2010 Cummins Power Generation, Inc. All rights reserved.

